

Rigel 288 - Electrical Safety Analyser



Instruction Manual

331A555 Issue 3.0

Limited Warranty & Limitation of Liability

Rigel Medical, part of the SEAWARD GROUP guarantees this product for a period of 1 year. The period of warranty will be effective at the day of delivery.

© Copyright 2009

All rights reserved. Nothing from this edition may be multiplied, or made public in any form or manner, either electronically, mechanically, by photocopying, recording, or in any manner, without prior written consent from the SEAWARD GROUP. This also applies to accompanying drawings and diagrams.

Due to a policy of continuous development the SEAWARD GROUP reserves the right to alter the equipment specification and description outlined in this publication without prior notice and no part of this publication shall be deemed to be part of any contract for the equipment unless specifically referred to as an inclusion within such contract.

Index

1. INTRODUCTION.....	8
1.1. Rigel 288 Design Philosophy.....	8
1.2. Key Features	9
1.3. Interfaces	10
1.4. Rigel 288 includes:	10
1.5. Optional Accessories	11
1.6. Test 'n Tag Compatible	11
1.7. Unique use of ICONS	12
2. LOGGING ON	- 13 -
3. SETTING-UP YOUR TESTER	- 14 -
3.1. Test Sequences.....	- 14 -
3.1.1. User definable tests.....	- 15 -
3.1.2. View, Delete or Copy an existing Test Routine.....	- 15 -
3.1.3. Modifying (Edit) Existing Test Sequences.....	- 16 -
3.1.4. Edit individual Test	- 18 -
3.1.5. Insert an individual safety test	- 19 -
3.1.6. Insert a non-electrical safety test.....	- 20 -
3.1.7. Create a new Test Sequence.....	- 23 -
3.2. Test Codes	- 25 -
3.2.1. Create New Test Codes	- 25 -
3.2.2. Configuring the Applied Part Module.....	- 27 -
3.3. Asset Trace Variables	- 30 -
3.4. System Config	- 31 -
3.4.1. Asset ID	- 32 -
3.4.2. After Test	- 32 -
3.4.3. Comments	- 33 -
3.4.4. Applied Part Results	- 33 -
3.4.5. Language.....	- 33 -
3.4.6. Check IEC lead Polarity.....	- 33 -
3.4.7. Date / Time	- 34 -
3.5. Blue Tooth Favourites	- 34 -
3.6. User Admin	- 38 -
3.6.1. Preferences	- 39 -
3.6.2. Change User	- 40 -
3.6.3. Change Password	- 40 -
3.6.4. User Profile	- 41 -

3.7.	Memory options	- 41 -
3.8.	Restore Factory Settings	- 42 -
4.	AUTOMATIC MODE	- 44 -
4.1.	Asset ID	- 44 -
4.2.	Test Codes	- 44 -
4.3.	Test Period	- 45 -
4.4.	Trace Variables	- 45 -
4.5.	Performing an Automatic Test:.....	- 45 -
4.5.1.	Semi Automatic Test Mode	- 45 -
4.5.2.	Failure Menu.....	- 46 -
4.6.	Test 'n Tag.....	- 55 -
4.7.	Options Menu	- 56 -
4.8.	View Results	- 56 -
5.	MANUAL MODE	- 57 -
5.1.1.	Earth Continuity	- 59 -
5.1.2.	Insulation Resistance EUT	- 61 -
5.1.3.	Insulation Resistance Applied Parts.....	- 62 -
5.1.4.	Insulation Resistance Applied Parts to Mains	- 63 -
5.1.5.	Equipment Leakage (Direct).....	- 64 -
5.1.6.	Equipment Leakage (Differential)	- 65 -
5.1.7.	Equipment Leakage (Alternative)	- 67 -
5.1.8.	Applied Part Leakage (Direct)	- 68 -
5.1.9.	Applied Part Leakage (Alternative).....	- 69 -
5.1.10.	Earth Leakage Test	- 71 -
5.1.11.	Enclosure Leakage Test.....	- 72 -
5.1.12.	Patient Leakage	- 73 -
5.1.13.	Patient Leakage – F-Type	- 75 -
5.1.14.	Patient Auxiliary Current.....	- 76 -
5.1.15.	Load Test	- 78 -
5.1.16.	IEC Lead.....	- 78 -
6.	VIEW DATA	- 80 -
6.1.	View Results	- 81 -
6.2.	Search the database	- 82 -
6.3.	View Data Options	- 83 -
7.	DATA TRANSFER	- 84 -
7.1.	Download to PC.....	- 84 -
7.2.	Upload from PC	- 86 -
7.3.	Configuration Data.....	- 86 -

7.3.1.	Send Config Data	- 86 -
7.3.2.	Receive Config Data.....	- 88 -
7.4.	Clone Data.....	- 89 -
7.5.	Load TnT Logo	- 89 -
8.	ABOUT.....	- 90 -
9.	MAINTAINING THE RIGEL 288	- 91 -
9.1.	Cleaning the Analyser	- 91 -
9.2.	User Maintenance	- 91 -
9.3.	Return Instructions.	- 92 -
10	TECHNICAL SPECIFICATIONS.....	- 93 -
APPENDIX A	DEFINITION OF IEC 60601 TESTS.....	- 95 -
APPENDIX B	PASS / FAIL LIMITS OF IEC 60601-1.....	- 102 -
APPENDIX C	DEFINITION OF IEC 62353 TESTS.....	- 103 -
APPENDIX D	PASS / FAIL LIMITS OF IEC 62353.....	- 108 -
APPENDIX E	IEC 60601-1 MEASURING DEVICE.....	- 109 -
APPENDIX F	FIRMWARE ROUTE MAP	- 110 -
APPENDIX G	AVAILABLE APPLICATION NOTES	- 111 -
APPENDIX H	CONNECTION DIAGRAM AP BOX	- 112 -

Declaration of Conformity

Rigel 288 Hand-held Electrical Medical Safety Analyser

Manufactured by:

Seaward Electronic Ltd, Bracken Hill, South West Industrial Estate
Peterlee, County Durham, SR8 2SW, England

Millennium Statement

This product is Millennium compliant, and conforms fully to the document BSI DISC
PD2000-1.

Statement of Conformity

Based on test results using appropriate standards, the product conforms with
Electromagnetic Compatibility Directive 89/336/EEC and Low Voltage Directive
73/23/EEC

Standards used:

EN 60601-1 (1990) Medical Electrical Equipment. General Requirements for Safety
EN 61010-1 (1993) Safety Requirements for Electrical Equipment for Measurement,
Control, and Laboratory Use

EN 50081-1 (1992) Electromagnetic Compatibility. Generic Emission Standard:
EN55022 Class B

EN 50082-1 (1992) Electromagnetic Compatibility. Generic Immunity Standard:
IEC1000-4-2, -4-3, -4-4, -4-5

The tests have been performed in a typical configuration.

This Conformity is indicated by the symbol , i.e. "Conformité Européenne"

WEEE Directive

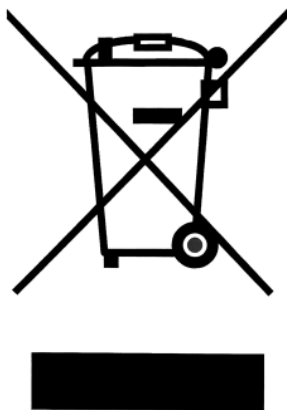

The Rigel 288 has been designed and manufactured with high quality materials and components, which can be recycled and reused.

Please inform yourself about the local collection system for electrical and electronic products or contact your local supplier for further information.

We ask you to respect your local rules and do not dispose of your old product with your general waste. By offering your old products for recycling, you will help prevent potential negative consequences for the environment and human health.

User Notes

These operating instructions are intended for the use of adequately trained personnel.

The following symbols are used in these operating instructions and on the Rigel 288.



Warning of electrical danger!

Indicates instructions must be followed to avoid danger to persons.



Important, follow the documentation! This symbol indicates that the operating instructions must be adhered to in order to avoid danger.



Warning, during many of the leakage tests the PROTECTIVE EARTH CONDUCTOR to the appliance under test is interrupted. For this reason additional means of protection are required in order to comply with the relevant safety standards. For EN60601-1 leakage tests, it is recommended that this additional protection is in the form of an isolation transformer, with an isolated reference ground, used to power the entire system.



Do not connect any probe combination to the maximum permitted voltage of 30 V AC/DC with respect to earth potential when performing non-power tests. Danger of electric shock.



Symbol used for tips and guidance notes in this manual.



Application note(s) available, see Appendix G.

1. Introduction

The Rigel 288 is the FIRST universal truly hand-held medical electrical safety tester to combine the features of an automatic / manual tester with a data logging / asset management facility. A compact lightweight design and long life battery power reduces downtime between tests, making the instrument totally practical and highly portable for multi site use.

In addition to IEC 60601-1 and AAMI / NFPA 99, the Rigel 288 tests to the new standard for in-service and after repair testing of medical electronic devices, currently drafted in as the IEC 62353. The Rigel 288's large internal memory facilitates the storage of test results for safety audit and traceability purposes. Comprehensive database software is available to ensure fast and easy download of test results, managing your asset database, creation of test sequences, scheduling of Preventative Product Maintenance and producing test certificates.

Wireless connection means that stored data can be transferred immediately and directly from the tester to PC-based record keeping systems at the touch of a button.

The highly versatile Rigel 288 represents the next generation of electrical medical safety analysers.

1.1. *Rigel 288 Design Philosophy*

The Rigel 288 has been designed to address the increasing demand for smaller more comprehensive test equipment within the Healthcare Industry. What better way than to combine such tester with the new International In-Service Test required as per IEC 62353.

The challenge was to combine the benefits of the size and weight of a smaller hand-held and portable Analyser with the test power and convenience of a larger bench-mounted automatic safety analyser. Today's industry demands test equipment that can save time and cost, thus offering greater flexibility. These factors have all been taken into account during the development of the Rigel 288. The test capabilities and functionality exceed that of most common bench mounted safety analysers yet the instrument is only a fraction of the size and weight.

No other safety tester on the market offers a hand-held enclosure with the test capabilities of that of an automatic safety analyser; including IEC 60601 and IEC 62353 leakage tests, up to 10 Patient Connections, alpha numeric keyboard, graphic user interface, large internal memory, Blue Tooth communication, asset management facilities, user configurable Performance Tests and more.

We believe that the new Rigel 288 is set to become the new standard in Electrical Medical Safety Testing.

1.2. Key Features

Versatile - Test in Accordance with the leakage requirements of

- ❖ IEC/EN60601-1 and
- ❖ IEC/EN 62353 as well as;
- ❖ AAMI and NFPA (USA version)
- ❖ AS/NSZ 3551 (Australian / New Zealand version)



Dedicated measuring devices are available according to IEC 60601 and AAMI requirements

Hand-held - Using purpose designed robust enclosure, the Rigel 288 is truly hand-held, easy to hold single handed thus enabling one hand operation and navigation

Easy to use - A full graphic, monochrome LCD display (1/4 VGA minimum) in combination with an integral alpha-numeric ABCD-key-board.

Manual and Automatic test modes - Able to perform UTS (Unique Test Sequence) and allows fully automatic, semi automatic and fully manual testing.

User definable test routines - Users have the ability to amend the default programs or create new programs by copying the preset test programs. Each program will have a unique Identifier.

Multiple Applied Part function - This feature gives the user the capability of testing up to 10 individual Applied Parts from different Modules or classes e.g. BF and CF class, or Bf ECG and Bf SPO2 module.

Internal Asset management facilities - Store up to 10,000 test records, custom test routines, visual inspections and performance tests and download to and from PC via Blue Tooth Interface.

1.3. Interfaces

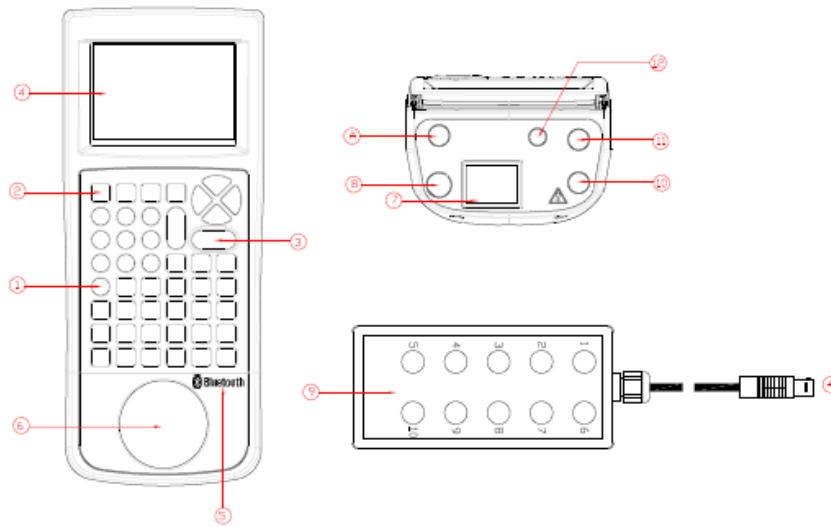

- 1) Alpha Numeric keyboard, Up / Down and Left / Right cursor control.
- 2) 4 Programmable soft keys below display
- 3) Larger Green and Red key
- 4) Full graphic Monochrome LCD, blue with white backlit, 1/4 VGA
- 5) Blue Tooth Input / Output
- 6) EUT socket to meet local requirements
- 7) IEC input socket (IEC lead test)
- 8) Custom detachable mains cable inlet
- 9) 10 way Applied Part adapter box (see appendix H for connection diagram)
- 10) 4mm Earth bond probe socket
- 11) 4 mm Earth bond Auxiliary socket
- 12) RS232 connection

1.4. Rigel 288 includes:

- Calibration Certificate
- Carrying Case
- Earth bond test probe with clip
- Earth bond clip lead
- Patient Applied Part adaptor box
- 10 Applied part adaptors
- Detachable 2 meter mains cable
- Blue Tooth USB dongle
- Electronic Instruction Manual
- Removable 'quick start' card

1.5. *Optional Accessories*

- Med-eBase PC Download software (p/n 301A920)
- RS232 download cable (p/n 331A952)
- Single Applied Part leakage lead (p/n 331A953)
- 10-way Applied part adaptor box (p/n 331A680)
- Bluetooth Barcode scanner (p/n 339A923)
- Bluetooth Test 'N' Tag System (p/n 331A950)
- Black & white cartridge (p/n 342A912)
- Bluetooth Test 'N' Tag Elite System (p/n 339A970)
- Bluetooth result printer (50mm) (p/n 339A930)
- Test 'N' Tag Elite roll of 180 labels (p/n 339A041)
- Rigel 288 filed service kit (p/n 331A923)

1.6. *Test 'n Tag Compatible*

The Rigel 288 is compatible with the Seaward Test 'n Tag and Elite system. Our Test 'n Tag systems allows you to print customised Thermal PASS / FAIL labels.

The benefits of using the Test 'n Tag printers are:

- Robust and durable labels
- Resistant to most solvents used in the medical sector
- Free opportunity to advertise your logo and company details or emergency telephone number with every item you Test 'n' Tag.
- Automatic barcode generation to provide easy use of the barcode scanner thus speeding up your test time.



The unique Test 'n' Tag label provides test status and retest due date, barcode and asset ID number, and person conducting the test. For more information on using the Test 'n Tag printer, see section 4.

1.7. Unique use of ICONS

The Rigel 288 features a hi resolution graphic back lit display which not only provides highly visible and easy to follow menu structures but also allows the user to operate the tester using intuitive icons to speed up their test routines.

Below are of some of the icons used in the Rigel 288:



Escape



OK – PASS



Add



Print

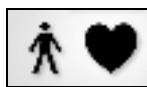

Applied Parts

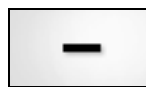

Less



Copy

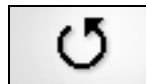

Repeat



Delete



Save



Edit



Search

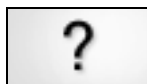

Help



Settings



Menu – List

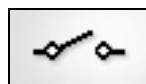

Single Fault



Home



Shift



New



Mute



Sound

2. Logging on

When switching on the Rigel 288, the user will be able to log-in to allow for specific default user preferences and to provide traceability of test results. To increase the security and protection of the user, a password can be set prior to using the Rigel 288. See 3.6.3 for further details. The default password setting is OFF and the login screen will not require a password. In case a user and password are set, the tester will default to the last user / password.

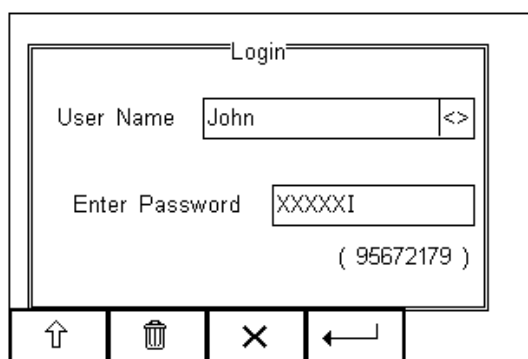

To change the user, use the drop down menu provided [<>] and select the new user. In case a password is set for the new user, please enter the password (case sensitive).



In case a password is lost and the unit is blocked, please call our helpdesk on: **+44 (0) 191 5878701** or contact your local distributor and quote the 8-digit code (shown below the password field) and the serial number of the tester to allow a temporary password being created. For security reasons, passwords can only be provided to the original purchaser of the device.

The Rigel 288 is designed to allow a user to customise test sequences and allow default settings. This customisation can speed up testing by providing the user with default manufacturer lists, model numbers, user text protocols, automatic printing post-text and fault menus.

3. Setting-up your tester

The Rigel 288 is designed to allow the user to customise the device to allow default setting in order to speed up the testing such as, default lists of manufacturers, model numbers, user test protocols, automatic printing following test, fault menu's and so on.

All custom facilities can be found under the SETUP menu. Simply press the  [F4] from the home screen and select Setup from the menu.



The underlined character acts as a short key to allow swift navigation through the menu structure.

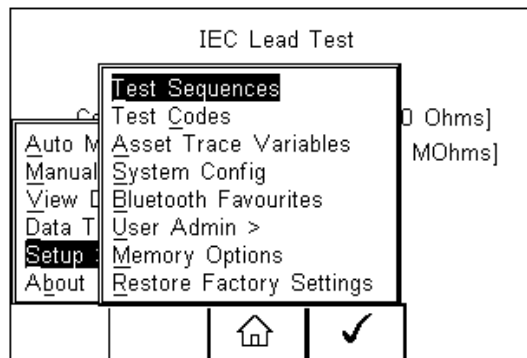

Available options

<u>T</u> est Sequences	Modify or create test sequences (see 3.1)
Test <u>C</u> odes	Generate 4-digit test routine short cuts (see 3.2)
<u>A</u> sset Trace Variables	Generate default list of variables (see 3.3)
<u>S</u> ystems Config	Configure default test options (see 3.4)
<u>B</u> lue Tooth Favourites	Setup your Blue Tooth devices (see 3.5)
<u>U</u> ser admin	Setup users and preferences (see 3.6)
<u>M</u> emory Options	Manage the tester's memory (see 3.7)
<u>R</u> estore Factory Settings	Defaults the tester to factory settings (see 3.8)

3.1. Test Sequences

The Rigel 288 can be set-up to create new test sequences to meet local requirements or to modify existing test sequences to meet personal preference.

The preset Test Sequences are according to the applicable medical standard. Preset test sequences cannot be changed by the user, however alterations are possible by producing a copy of the default test sequence setting.



The total number of possible preset test sequences is 50 including 12 default test sequences. Each sequence can be linked to a specific configuration of Applied Parts by designating a unique 4 digit Test Code (see 3.2) which can be entered prior to each test as a short cut / menu bypass function.



3.1.1. User definable tests

This feature gives the Rigel 288 the capability of recording user defined visual inspections, checks or tests including measurements from SPO2, ECG, NIBP, Defib, Infusion, Ventilation, Pressure etc.

The input is text only as no measurements are performed by the Rigel 288 during these tests. The user can enter questions or instructions followed by either a PASS/FAIL result or alpha numeric input. Preset engineering units e.g. %, Joules, mmHg, PSI, CmH2O etc are available.

3.1.2. View, Delete or Copy an existing Test Routine.

Preset test sequences cannot be deleted or changed by the user however, alterations are possible by producing a copy of the default test sequence.

To enter the Test Sequences menu, click on , followed by Setup. Select the Test Sequences from the list and press  (F4).

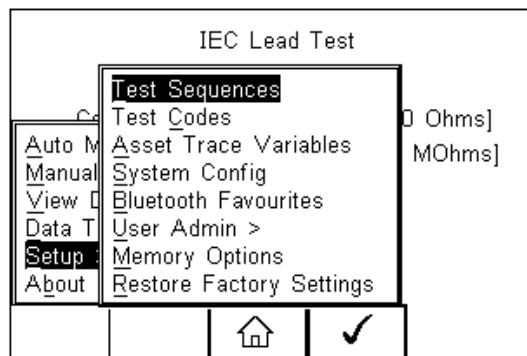

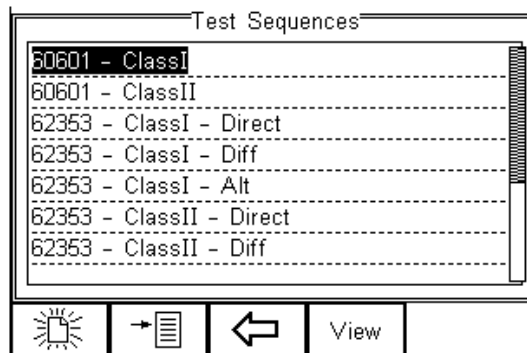

The following overview is provided and shows the list of default and customised test sequences available. Copied Test Sequences will appear in the list with an *pre-fix.

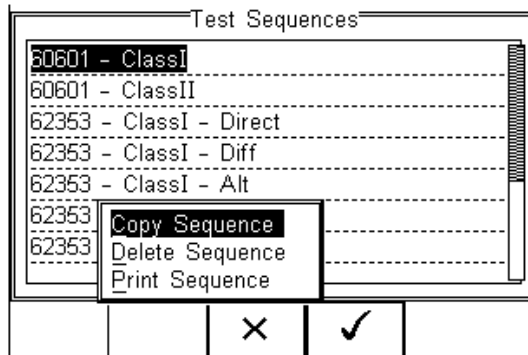

From this menu, the user is able to View a test sequence by pressing the View button (F4). Default test settings cannot be altered at any stage.

To Copy, Delete or Print an existing or default test sequence, use the Up & Down arrow keys to highlight the test sequence and press the  button (F2).



Use the Up & Down Arrow keys to select the required action and press the  (F4) to confirm. Press Escape (F3) to cancel and return to previous screen.

Copied Test Sequences will appear in the list with an *pre-fix. All Copied test Sequences can be edited. See 3.1.3 for more on editing test sequences.

Print Test Sequence will provide an overview of the Test Sequence on the Favourite Blue Tooth Printer. See 3.5 for help on setting up Blue Tooth devices.

Delete Sequence will remove the highlighted test sequence from the memory of the Rigel 288.





Default Test Sequences cannot be Deleted.

3.1.3. Modifying (Edit) Existing Test Sequences

Preset test sequences cannot be modified by the user, however alterations are possible by producing a copy of the default test setting (see 3.1.2).

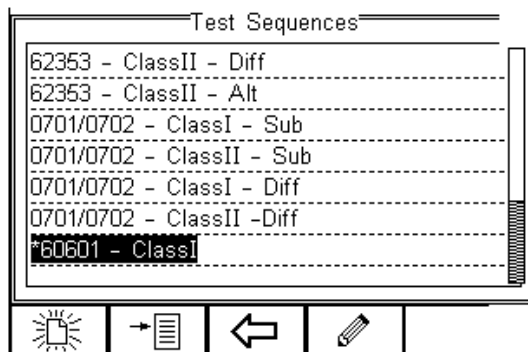
Non-default Test Sequences can be modified from the Test Sequences menu. When non-default Test Sequences are highlighted, the  (F4) will appear in the menu screen.



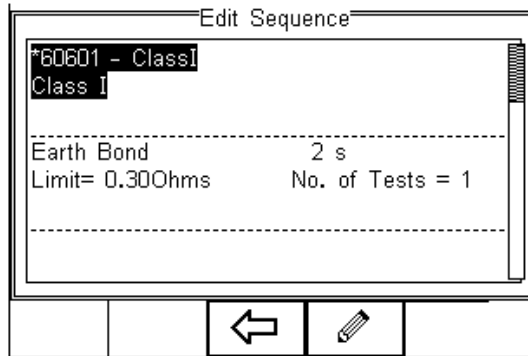

Pressing the  button (F4) will open the Test Sequence for Editing as shown below;



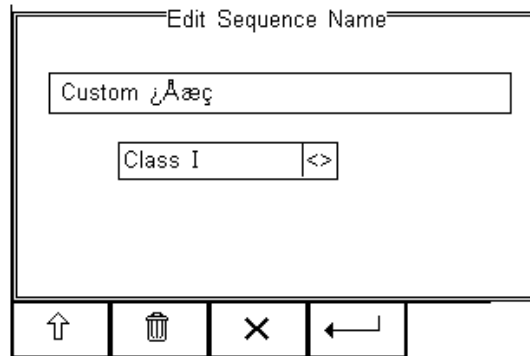

To change the Name and or Class of the Test Sequence, press the  Button (F4) and enter the Name and or Class required.





To change to upper or lower case or use language specific characters, press the  button (F1) and select the required entry.

To Delete a character, press the  button (F2)

To return to the previous menu without changes, press the  button (F3)

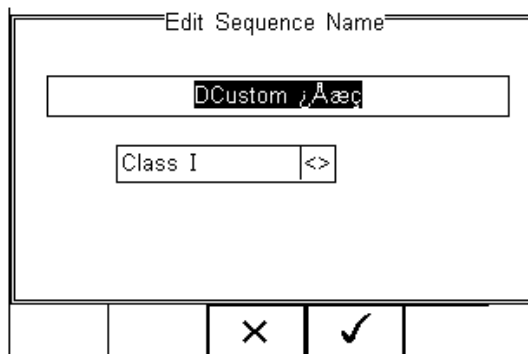
To confirm the entry, press the  button (F4)



Confirm the changes with the  button (F3) or cancel using the  button (F4).

To Insert a new test, highlight the test using the Up & Down arrow keys and press the Insert button (F1)

To Delete an individual test, highlight the test using the Up & Down arrow keys and press the  button (F2)

To go back to the previous menu, highlight the test using the Up & Down arrow keys and press the  button (F3)

To modify an individual test, highlight the test using the Up & Down arrow keys and press the  Button (F4)

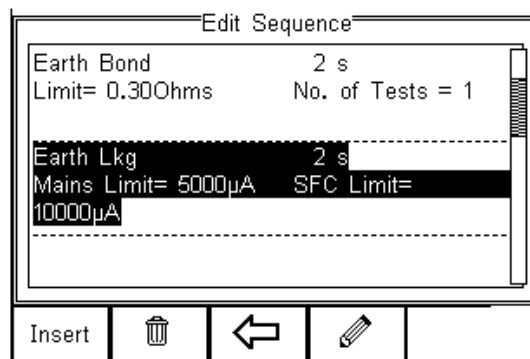



3.1.4. Edit individual Test

Press the  button (F4) as shown above. The sub menu will allow you to alter the settings for; Test duration, Mains Limit, Single Fault Limit, Neutral Open*, Earth Open*, Mains Reversal*.



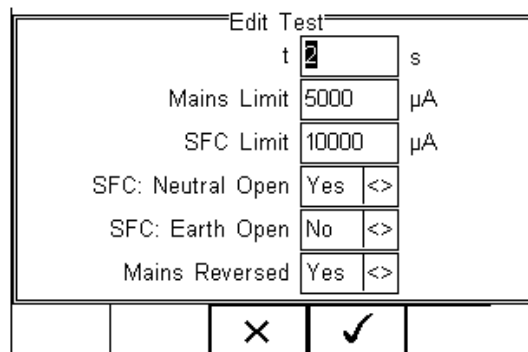



Default test sequences have the appropriate Single Fault Conditions set to meet the Standard Requirements. For specific use, Single Fault Conditions could be de-activated by selecting the drop down box using the up and down keys and highlight the drop down box. Change the content using the left and right keys.



Highlight the required field using the up and down keys. To change the content either use the left and right keys or use the keypad to enter the correct data. To Delete the field content, press the  button as shown below.

Edit Test		
t	15	s
Mains Limit	5000	μA
SFC Limit	10000	μA
SFC: Neutral Open	Yes	<>
SFC: Earth Open	No	<>
Mains Reversed	Yes	<>

When the right settings have been achieved, press the  button (F4) to save the changes or press  (F3) to return to the previous menu without changes.

Repeat this action for every test that requires editing. Once all the requires tests are programmed, press  (F3) to exit.

3.1.5. Insert an individual safety test



To insert an individual safety test we use the up and down keys to highlight the position where a new test needs inserting and press the Insert button (F1) from the menu below.



Tests will be inserted before the highlighted position not after.

To modify a test sequence, please refer to 3.1.3.

Edit Sequence	
Earth Bond	2 s
Limit= 0.30Ohms	No. of Tests = 1
Earth Lkg	2 s
Mains Limit= 5000μA	SFC Limit=
10000μA	

Insert

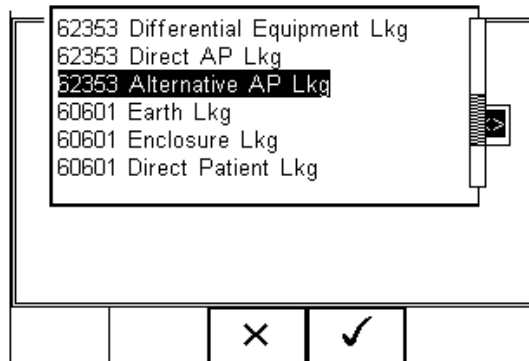

Once the Insert button (F1) has been pressed, a drop down box will appear with all available safety and inspection tests. Activate the drop down box using the left key and or scroll through the available tests using the up and down keys.

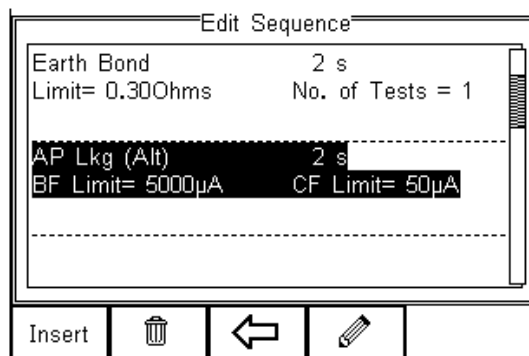

Once the desired test has been highlighted, confirm using the OK button (F4) and finally confirm to insert into the test Sequence. Pressing the **X** button (F3) will return to the previous screen without changes being made.

The individual test has now been inserted and can be edited as described in 3.1.4



Further electrical safety tests can be inserted or deleted by following the steps described herein.

Proceed with non-electrical safety tests as described in the following or save the new Test Sequence by following the steps below.

3.1.6. Insert a non-electrical safety test

Non-electrical safety tests are intended to allow the user to capture additional information either prior to or after a safety test is completed. Such information could indicate the performance of the Medical Device (eg NIBP reading, Defibrillator Energy, Flow rate on Infusion device, SPO2 reading etc).

This feature can also be used to instruct the user to inspect certain criteria (eg. Labels, software version, certain damage or upgrades) prior to a safety test as part of the Visual Inspection. To create customised visual inspections, use the insert Custom Test function using the instructions below and set the engineering units to blank.



Create a unique range of visual tests or instructions by creating a new test sequence (see 3.1.7) and select Custom Test as the nature of the test. This will create a unique test sequence which can be linked to other Test Sequences or Applied Part Configurations using Test Codes. See 3.2 for more information. This allows the user to insert default customised visual checks or performance tests (eg when testing NIBP monitors, Defibrillators etc)



The maximum number of **characters** in the test description or instruction is 255.

To insert a non-electrical safety test, highlight the place where a new test needs inserting using the up and down keys and press the Insert button (F1) from the menu below.

Note; Tests will be inserted before the highlighted position not after.

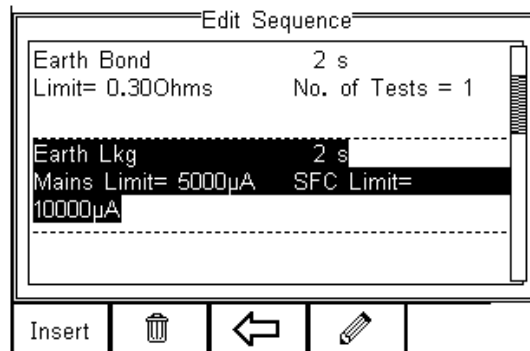

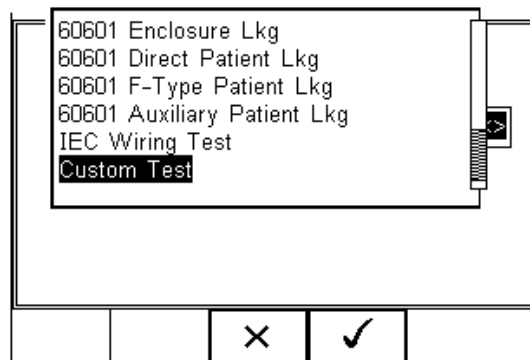

Once the Insert button (F1) has been pressed, a drop down box will appear with all available safety tests and inspection available. Activate the drop down box using the left key and select the Custom Test option.



Confirm using the  button (F4). The following menu will define the nature of the non-electrical safety test (eg Equipment performance check at the end of a safety test).

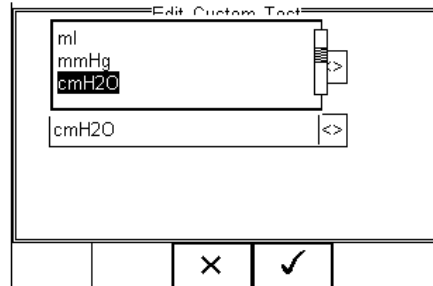
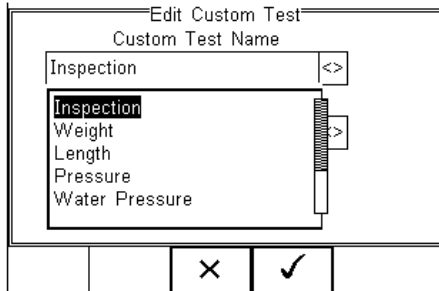

Use the drop down box to choose a preset instruction and engineering unit or simply type in the boxes provided. Newly entered data will be added to the drop down box on a first come first serve basis.

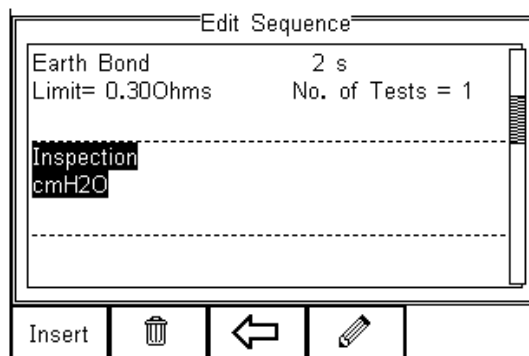

To insert the new Custom Test, press the  button (F4) or exit using the  button (F3) and return to the previous screen without changes being made.



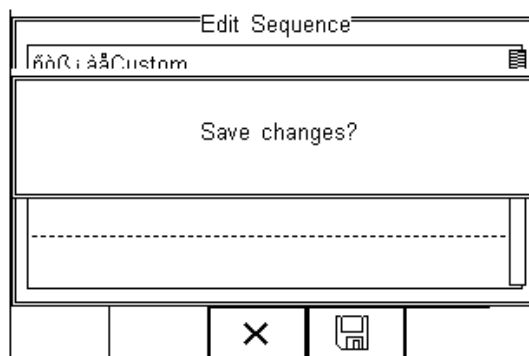

Further tests can be inserted or deleted by following the steps described herein.

Save the changes for future use by pressing the  key followed by the  button. If the Escape button (F3) is pressed, the Rigel 288 will return to the previous meny without changes being made.



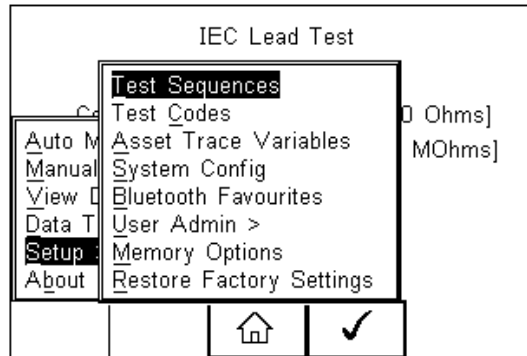

3.1.7. Create a new Test Sequence

To create a new Test Sequence, enter the Test Sequences menu by clicking on , followed by Setup. Select the Test Sequences from the list and press  (F4).

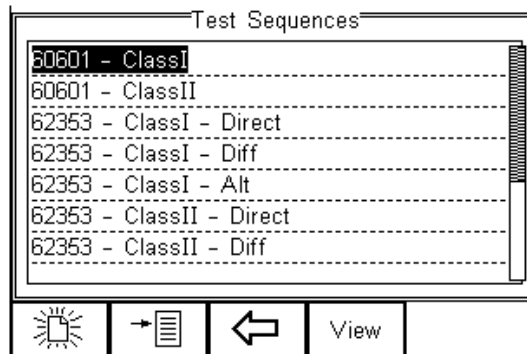

The following screen displays the list of default and customised tests available. Copied Test Sequences will appear in the list with an *pre-fix.





From this menu, the user is able to create a new Test Sequence by pressing the  button (F1) .

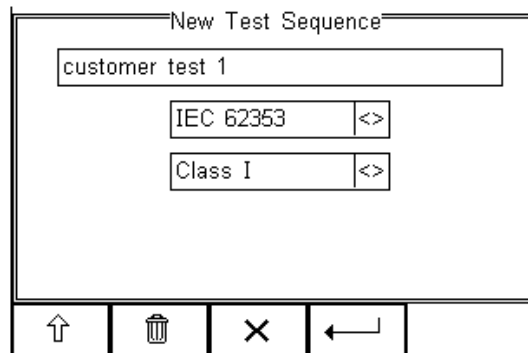

When choosing any of the standards other than –NONE-, all applicable individual tests will be activated and are available for modification. To modify a Test Sequence, please refer to 3.1.3. (test standards are not part of this screen in firmware versions 2.11 and higher)



When choosing Test –None-, the Test Sequence will only be set to an Inspection. Refer to 3.1.6 for further details.

When the text box is activated and text is entered, function keys F1  and F2  appear automatically. In this instance 'customer test 1' has been created as Test Name, with Class 1 and to Test Standard IEC 62353.





To change to upper or lower case or use language specific characters, press the  button (F1) and select the required entry.

To Delete a character, press the  button (F2)

To return to the previous menu without changes, press the  button (F3)

To confirm the entry, press the  button (F4)

Next step is to save the name of the newly create Test Name, by pressing the OK button (F4). Pressing the  key (F3) would return to the Test Sequence menu without changes.

The newly created Test Name now appears in the Test Sequence menu and can be modified to include the required individual tests. Press the  button (F4) to open the sequence for editing.

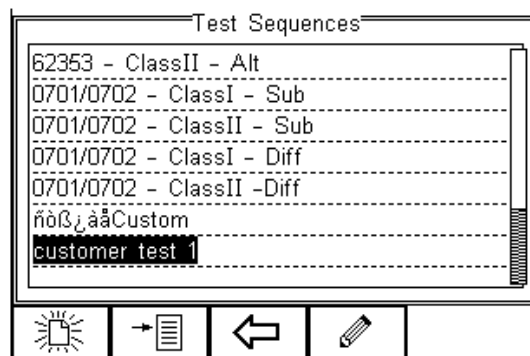

Once the Test Sequence has been opened, individual tests can be inserted by highlighting the place where a new test needs inserting using the up and down keys.



Note; Tests will be inserted before the highlighted position not after.

To modify a test sequence, please refer to 3.1.3

3.2. Test Codes



Test codes can be used to create a 4-digit 'short cut' code in order to group custom and or pre-set test(s), Applied Part configurations and test setup in either Automatic or Semi Automatic mode. See section 4.1 for Automatic vs Semi Automatic testing.

For example, a specific brand or make of patient monitor is PC based, has a start-up time of 1 minute and requires a specific Visual Inspection followed by a Semi Automatic (see 4.1.1) Electrical Safety Test and Functional Test sequence (see 3.1 for more information on various Test Sequences). In addition the patient monitor has a specific configuration of Applied Parts. All this information can be grouped under a 4-digit Test Code and will speed up the tester setup significantly. Once the 4-digit code is entered in the (Semi) Automatic Test, the Rigel 288 is preset with all test settings applicable to the device under test.

3.2.1. Create New Test Codes

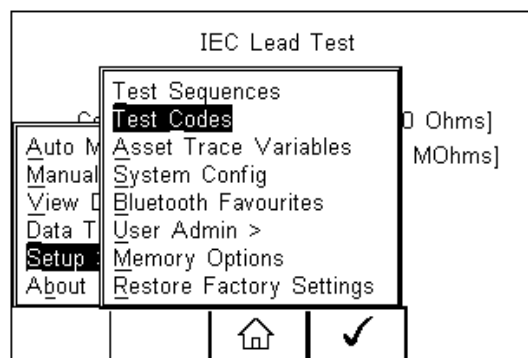
To create a Test Code, press the  button (F4) from the home screen, select Setup from the menu and select Test Codes from the list as shown below.



Press the  button (F4) to select Test Codes. Press the  button (F3) to return to the Home screen.

The following screen displays the initial menu in which New Test Codes can be created (F1), existing Test Codes can be Edited (F4) or Deleted (F2). Press the  button (F3) to go back to the Home screen.

Press the  button (F1). This will provide you with the first Test Code, TC01.



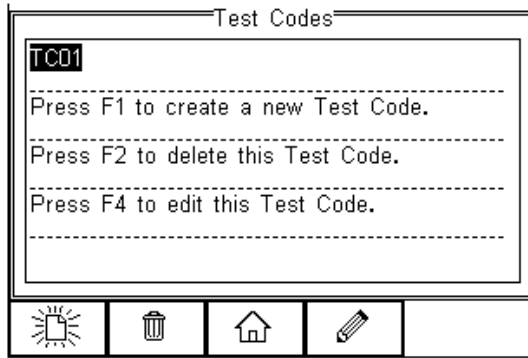

Test Codes require a 4-digit number and as such, the name MUST be changed to a 4-digit number before it can be used.

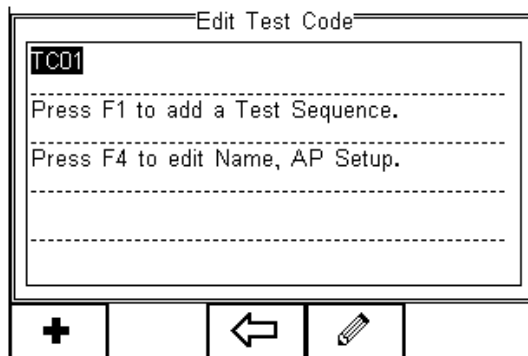

The first Test Code has now been made available but requires a unique 4-digit code, followed by a number of functions / configurations to be grouped.

Press the  button (F4) to configure the Test Code.



Press the  button (F4) to allocate a unique 4-digit code and or to configure the Applied Part setup and test mode to Semi or Full Automatic.

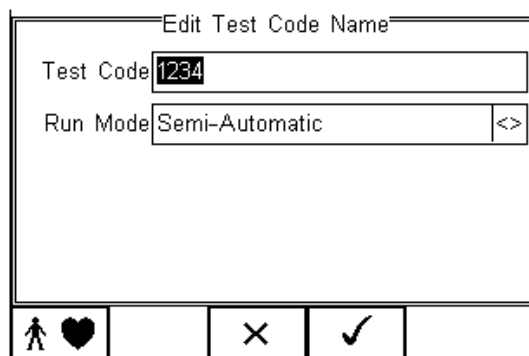

Enter a 4-digit Test Code, in this example 1234, and use up. Down. Left and right keys to select either Semi Automatic or Automatic. (see 4.1)

3.2.2. Configuring the Applied Part Module

To configure the Applied Part settings, press the  button (F1)

The following screen presents a default setup for:

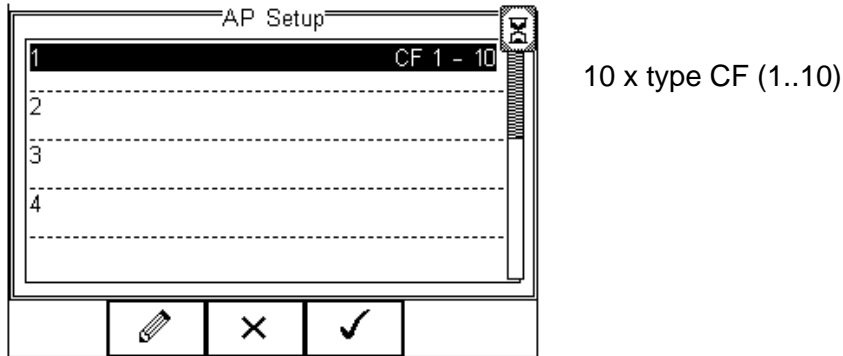

The numbers on the left 1...10 define the Applied Part number, the numbers in each line (eg 1-3) define the number of Patient Connections within that Applied Part. Each Applied Part can also be given a name to increase the traceability.

To change the default settings, highlight the Applied Part that requires modification or configuration and press the  button (F2).

In this example we change Applied Part 1 to be a 5-lead ECG type CF and Applied Parts 2 to be Defibrillator Pads BF (2). Applied Parts 3 will be deleted.

Highlight Applied Part 1 and press the  button (F2)

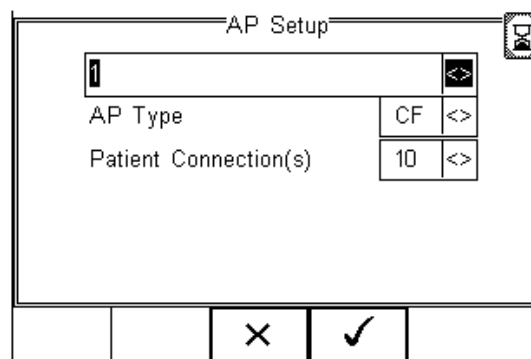

Edit the first line or use the up, down, left and right keys to select from a list of default names. Any new name entered will be added to the default list for future reference.





A maximum of 20 Applied Parts names can be held within the default list. Any additional entry will replace an entry on a first in first out basis.

Use up, down, left and right keys to set AP-type to CF and Patient Connections to 5

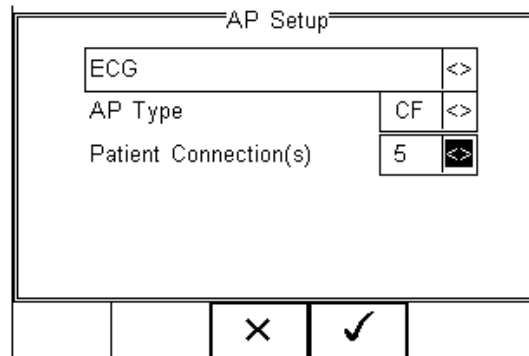

Below presents the AP Setup screen with the required changes.



Confirm with the  button (F4) or exit using the  button (F3).

Highlight Applied Part 2 and press the  button (F2)

Repeat the actions above and select Defib Pads from the drop down box in the AP Setup screen. Set the AP type to BF and Patient Connections to 2.

Confirm with the  button (F4) or exit using the  button (F3).

The following screen shows an example Applied Part Configuration still showing Applied Part 3 (CF 8..11).

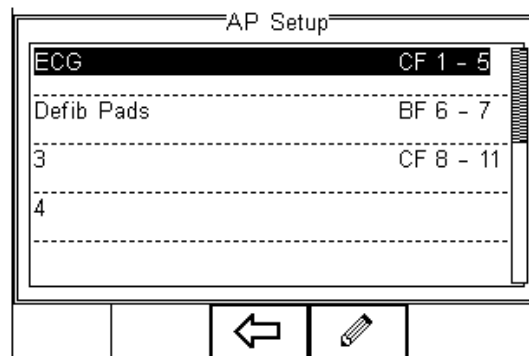

To delete Applied Part 3, highlight line 3 using the Up & Down Keys and press the  button (F2).

There are two options to delete an Applied Part.

Option 1:

Set the AP type to BLANK and leave the Patient Connections to 4; This would not ignore Connections 8-11 in an electrical safety test. However additional Applied Parts are not possible as the maximum number of connections is 10.

This feature could be useful to blank a number of connections between Applied Parts and can be done by inserting a BLANK AP type with an applicable number of connections in between B, BF or CF Applied Parts.

Option 2:

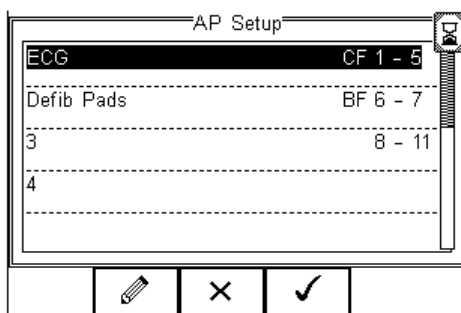

Set the AP type to BLANK and the Patient Connections to 0; This would delete the whole Applied Part and free up the remaining connections.



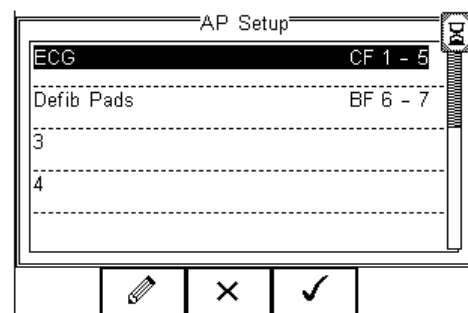

Option 1

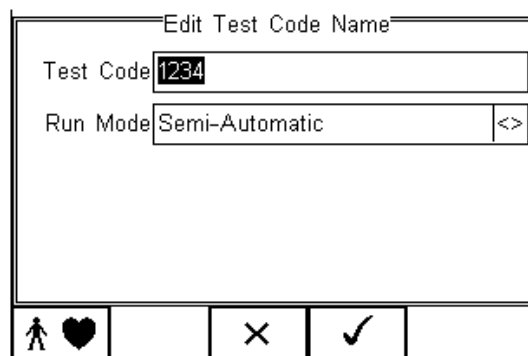

Option 2

Confirm with the  button (F4) or exit using the  button (F3).



When returning to the Edit Test Code Name screen, confirm and save the Test Code by pressing the  button (F4), see below.

Be aware, pressing the Escape button (F3) would return to the initial test code screen and default settings. All information will be lost.

Test Code 1234 has now been configured and saved. The screen below shows the available Test Code(s) and is / are available for use in the Automatic test mode. (see 4.1)

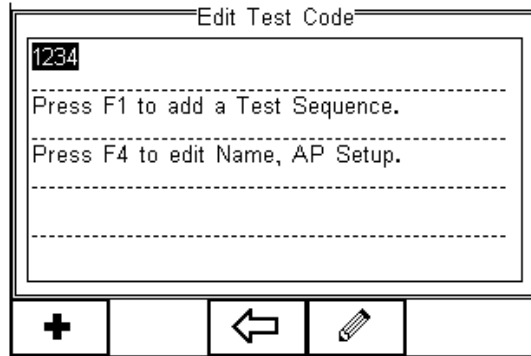

To create further Test Codes, press the **+** button (F1) and repeat the actions as described in 3.2

Once all Test Codes have been completed, save all data by pressing the **←** button (F3) and confirm the changes made.

To return to the Home Screen, press the **🏠** button (F3) see below.

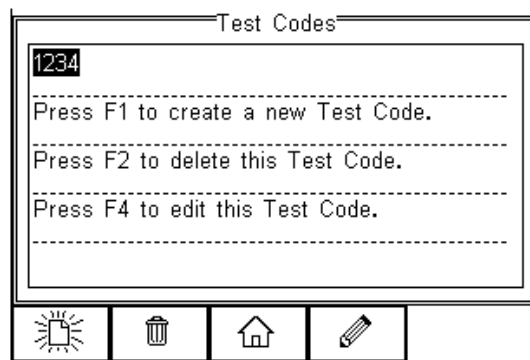

3.3. Asset Trace Variables

The Asset Trace Variables allow the user to include valuable data to the test results to enhance the traceability and to provide increased search criteria when using database software. Asset trace variables may consist of a maximum of 25 characters and can be selected prior to each electrical safety test when using the Rigel 288 in automatic mode.

The following variables can be added to the test results:

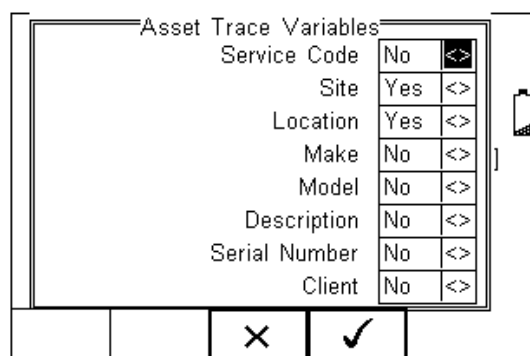



See 3.4.1 for more information on the use of Asset Trace Variables.

The default settings on the Rigel 288 include the Site and Location variables. Both are activated. The drop down box is set to [Yes].

To activate or de-activate each variable, use the up and down keys to select the variable and the left and right keys to select yes or no.

Once a variable has been activated, the user is given the ability to enter Trace Variables prior to a safety test by selecting from or adding to the list of default items. Each variable entered during the automatic test will automatically be added to the list for future use.

Trace Variables that are de-activated (set to NO) will not appear during the automatic tests.



A maximum of 40 individual entries are available for each Trace Variable. Additional entries will overwrite on a first in first out basis.



3.4. System Config

This feature can setup the Rigel 288 to automatically perform certain features during or after a test as well as allowing the user to set Time and Date preference.

To select System Config, press the  button (F4) followed by Setup in the menu and System Config from the list as shown below;

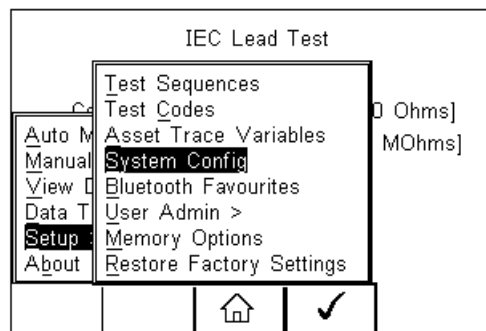

The System Config menu is displayed below;

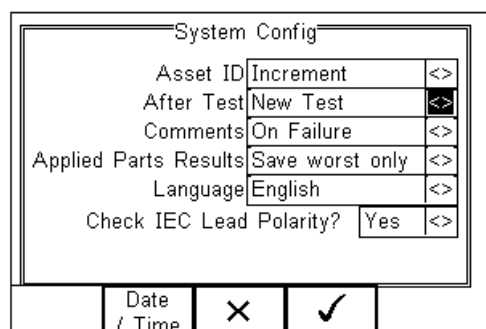

The System Config menu provides the following features:

3.4.1. Asset ID

Provides automatic Asset ID configuration. Use the Left & Right Keys to select between

- Increment - Automatically increments the next Asset ID's least significant number by 1
- Blank – Will leave the next Asset ID field blank
- Repeat Last - Will copy the previous Asset ID into the next Asset ID field



The Asset ID field is used to store (and identify) the record in the Rigel 288 database. Additional input fields, referred to as ASSET TRACE VARIABLES are available to distinguish between identical Asset ID records, ie when the ASSET ID field is used to enter the Model or 4 digit fast code. The benefit of using the Rigel 288 in this way is that similar items can be easily retested using the same parameters. When an existing ASSET ID is entered in the 288, the tester will automatically configure itself to re-perform the test without any additional settings being required. By using ASSET TRACE VARIABLES, each ASSET can be given a unique identifier in the database ie through the use of a serial number. A representation is provided below;

Asset ID (database record)	Asset Trace Variables							
	Service code	Site	Location	Make	Model	Description	Serial Number	Client
001	PPM	Site 1	Loc 1	JBM	X3000	ECG	1234er	NHS
001	PPM	Site 1	Loc 1	JBM	X3000	ECG	5678ty	NHS
001	PPM	Site 1	Loc 1	JBM	X3000	ECG	0986gh	NHS

Identical ASSET RECORDS are also differentiated by TIME/DATE stamp, thus ensuring no records are overwritten.

3.4.2. After Test

Provides automatic action after a test is completed. Use the left and right keys to select from the following

- New Test – Automatically brings up the next test screen.
- Download – Automatically down loads the test results to the PC (see 7.1)
- Print Label – Automatically prints the test results to a thermal printer
- Test 'n Tag – Automatically prints a Test 'n Tag label. (see 4.2)
- Options Menu – Provides a menu to allow further choices after a test. (see 4.3)

3.4.3. Comments

Provides the ability to enter further comments after successful or failed tests. Use the left and right keys to select from the following

- Always – Comment field is displayed after each passed or failed test.
- On Pass – Comment field is displayed after a passed test only.
- On Failure – Comment field is displayed after failed test only
- Never – Comment field is not displayed.

3.4.4. Applied Part Results

Provides the ability to change the amount of patient leakage data stored to save memory and keep reports short and relevant. Use the Left & Right Keys to select between

- Save Worst Only – Automatically saves the patient connection within an applied part with the highest reading for a specific normal or single fault condition provided all patient connections pass the test.
- Save All – All patient connections in all applied parts are saved.

3.4.5. Language

Provides the ability to change the default language in the Rigel 288. A total of 6 languages are available;

- ❖ English
- ❖ German
- ❖ French
- ❖ Spanish
- ❖ Italian
- ❖ Turkish

Use the up, down, left and right keys to select from the available languages. Additional languages can be made available, please contact our support office at +44 (0) 191 5878701.

3.4.6. Check IEC lead Polarity

Provides the ability to set the Rigel 288 for polarised (eg UK 3-pin) or non-polarised (eg Schuko 2-pin) mains supplies.

- Yes - Automatically checks for incoming mains reversal and includes a Live Neutral polarity check during an IEC lead test. The Rigel 288 will display a message during power-up in case incoming mains is reversed
- No – Incoming mains reversal and IEC polarity checks are disabled. No mains reversal messages are displayed at power-up.

3.4.7. Date / Time

Allows the user to set the current date / time and preferred formats.

Press the Date / Time button (F2). The following menu will be displayed;

Date / Time	
Date Format	dd Month yyyy <>
Time Format	AM / PM <>
Day	18
Month	Jan <>
Year	2007
Time	17:45

Buttons: [] [X] [✓]

Date Format: Use the Left & Right Keys to set the date format to dd Month yyyy or mm / dd // yyyy

Time Format Use the Left & Right Keys to set the time format to AM / PM or 24 hour

Day Enter current day

Month Use the up, down, left and right keys to select the current month

Year Enter current year

Time Enter current time. Use the ':' (F1) to separate hours from minutes to ensure the correct time is entered and saved.

Confirm the settings by pressing the  button (F4)



Once all System Configurations have been completed, press the  button (F4). Changes are saved automatically.

3.5. Blue Tooth Favourites

In order for the Rigel 288 to automatically connect to the correct Bluetooth accessory, details of that accessory must be entered into the Bluetooth Favourites list.

The Bluetooth Favourites list comprises of three sub-lists (device types), each of which can store up to 3 accessories of the same type. The three sub-lists are shown below:

- Barcode (Scanner)
- Printer
- Computer

To select Bluetooth Favourites, press the  button (F4) followed by Setup in the Menu and Bluetooth Favourites from the list as shown below. Press  (F4) to select;

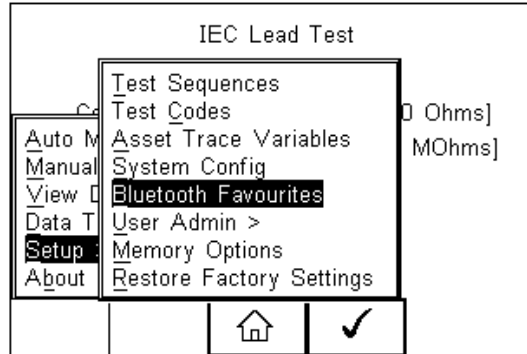

The following shows how to add a Computer to Bluetooth Favourites.

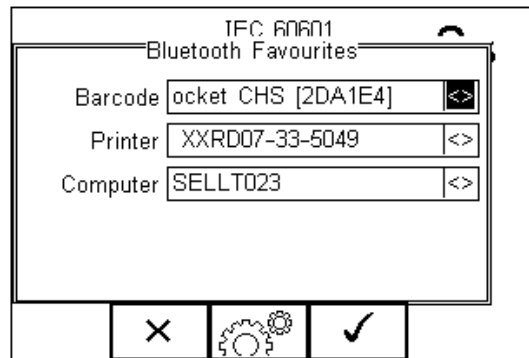

Use the up/down arrow keys to highlight the device type (in this case Computer) then press  (F3).

Make sure that the device you want to add to your new favourites is switched on.

Press  (F1). The Rigel 288 will search for all discoverable Bluetooth devices within a 10m range. The time taken to perform the search will vary depending on the number of Bluetooth devices in range.

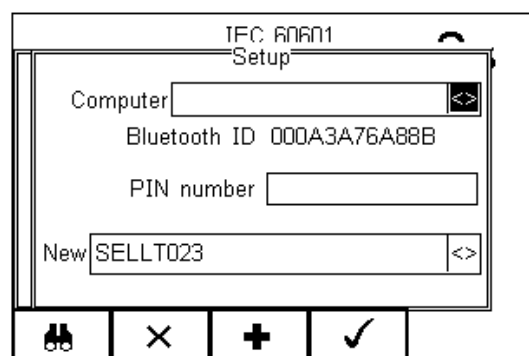

Wait for the progress bar to complete.

Use the arrow keys to highlight the field labelled “New” and press the left or right keys to open the list of devices which have been found during the search.



If more than 10 Bluetooth devices have been found the list will show the last 10 devices found.

In the following example, the search has identified Bluetooth devices named “SELLT023”, “Shaz” and “V-equals”

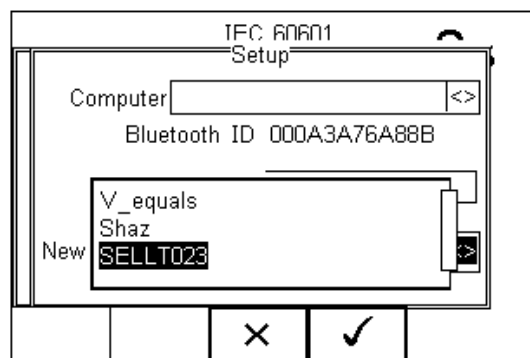

If the required device is not shown, check that it is powered on with the Bluetooth function active then repeat the search.

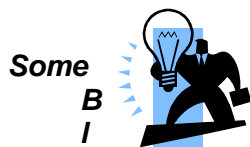

***Some
B
I***

uetooth devices do not report a recognisable name and may cause confusion when setting up Favourites. Turn off or disable unused Bluetooth devices when configuring Favourites.

Use the up/down keys to highlight the required device (in this case SELLT023i) and press the  button (F4). **SELLT023** is now placed in the “New” field as shown below.

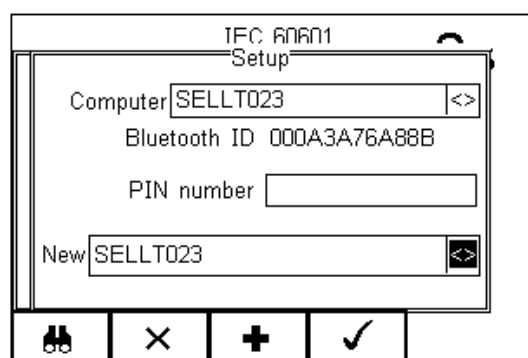

Press **+** (F3) to add SELLT023 to the Favourite Computer list.

To add further devices to the list of available computers select the new field again, use the up, down, left and right keys to select the required device and press **+** (F3) to add the chosen device.

“SELLT023” has been added to the Computer field with **Bluetooth ID**.

Press **✓** (F4) to store the changes and return to the previous screen.

A PIN number can be entered if required for the device to be added to the Favourites list.



Seaward and Rigel accessories do not require a PIN. For other Bluetooth devices refer to the manufacturer's documentation.



Devices that are not required can easily be removed by selecting the Computer field, pressing the left or right keys to open the list, highlighting a device using the up/down keys and pressing **☒ (F2).**

Confirm the deletion by pressing the **✓ button (F4). Press the **✓** button (F4) to save Bluetooth Favourites settings.**

All Bluetooth devices have a unique ID. The Bluetooth ID is shown when a device is added to the Favourites list.

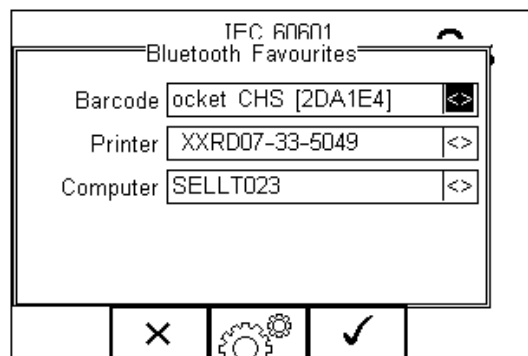

“SELLT023” is now a Bluetooth Favourite and the Rigel 288 will automatically establish a connection with “SELLT023” when using functions that communicate with a computer e.g. downloading records to a PC database software package.

Note: Press **X** (F2) to exit without saving changes.

Press  (F3) if necessary, to select another device..

Press  (F4) button to save changes.

When all your favourite devices have been set up, press  (F4) and they will be saved.

3.6. User Admin

The User Admin feature allows the user to personalise the way in which the tester behaves during normal use and include features such as:

- Preferences (see 3.6.1)
- Change User (see 3.6.2)
- Change Password (see 3.6.3)
- User Profile (see 3.6.4)

To enter the User Admin feature, press the  button (F1) from the home screen, select Setup followed by User Admin.

The following menu will appear:

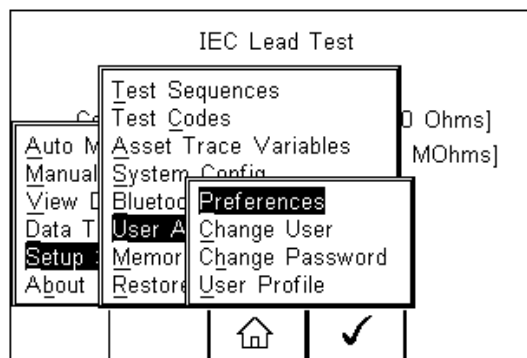

Navigate through this menu using the Up & Down Keys and select by pressing the  button (F4) or the right arrow key.

3.6.1. Preferences

Provides means of configuring the default settings of the tester's behaviour during normal use. All settings are user specific and stored against the logged-in user :

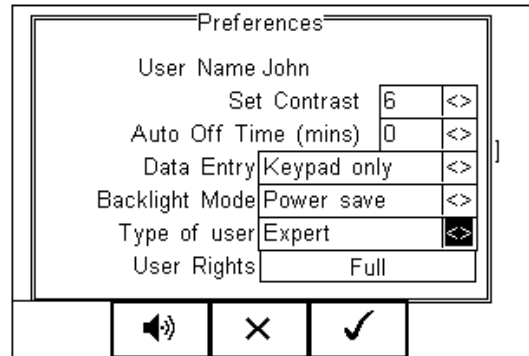

- **Set Contrast** – Use the up, down, left and right keys to set the contrast
- **Auto Off Time (mins)** - Use the up, down, left and right keys to set the power off time on the tester. Settings between 0- 10 minutes. Note 0 minutes will deactivate the AutoSwitch Off feature.
- **Data Entry** – Sets the tester up to take data entry from Barcode or Keypad only. Use the up, down, left and right keys to select Barcode or Keypad only.



In data entry mode the unit will automatically try to connect to a barcode scanner via the internal Bluetooth module – if the scanner is available this feature will drain the batteries unnecessarily. In this instance it is recommended that the unit be set to Keypad only.

- **Backlight Mode** – Chose between Always Off, Always On, Power Save (Back light on for 30 secs after each key press). Use the up, down, left and right keys to select.
- **Type of User** - Use the up, down, left and right keys to select between Novice and Expert. Novice users benefit from additional instructions throughout the safety tests. The Expert setting removes those additional instructions. These instructions are:
 - 1 *Warning message before the first Insulation test in auto mode*
 - 2 *Warning message before the first EUT power on in auto mode*
 - 3 *Warning message if user tries to execute a Test Code that has missing test sequences.*
- **User Rights** – For information only. To change the user rights, see 3.6.4

The  (F2) button allows the user to set the audible warnings and beep on key presses. See menu below:

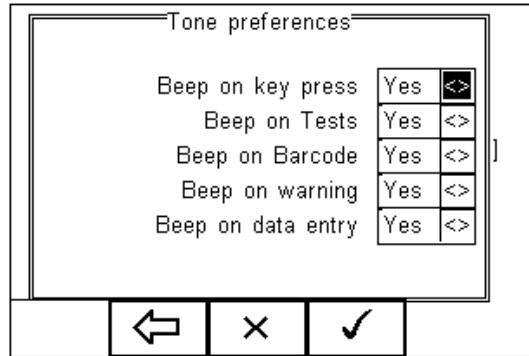

Navigate using the Up & Down Keys and change between Yes / No using the left key.

Confirm the settings using:

- ✓ button (F4) this will return to the Home screen
- ← button (F2) will return to previous menu and save data.
- ✗ button (F3) will return to the home screen without changes being saved.

3.6.2. Change User

This feature allows an operator to default to a different existing user or setup a new user. Admin rights are required for this feature. Alternatively, new users can be created in the User Profile menu, see below.



A brand new Rigel 288 will automatically default to admin rights so new users can be created.

3.6.3. Change Password

This feature allows a new password to be assigned or changes to an existing password.

To create a new password, highlight the New Password field using the Up & Down Keys and enter a new password followed by confirmation of the new password. Use the

← key (F4) to finish and press the ✓ button (F4) to confirm and save the new password.

To change an existing password, enter current password and repeat the steps above. See menu below for an overview of the Change Password screen.

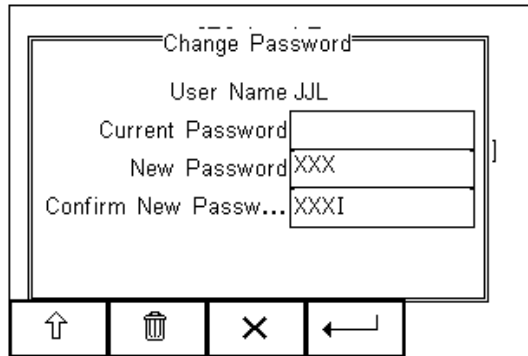

3.6.4. User Profile

This feature allows the administrator to setup new and existing users and inhibit or assign certain features to individual users.



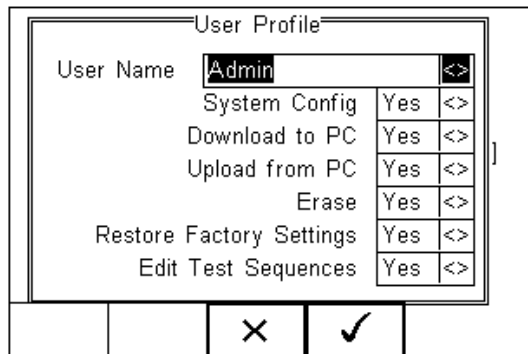

That the User Profile is only valid when the ADMIN user has been setup with a PASSWORD. See item above. If no ADMIN password has been set, all users have FULL User Rights.

Select the applicable user name, use the Up & Down Keys to navigate through the menu, use the Left & Right Keys to activate (yes) or de-activate (no) certain features. See menu below.



Press the  button (F4) to save user profile.

3.7. Memory options

This feature is used to view information about the Rigel 288 memory status. Press  (F4), select setup using the up/down keys and select Memory Options by pressing the  (F4) to accept.

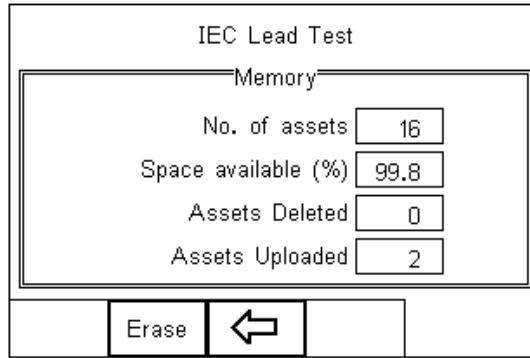

The display shows the number of asset records currently stored, the remaining memory space, number of assets deleted and number of assets in upload memory.

The nature of Flash memory is such that when records are deleted only the reference to the data is removed. The data still remains and will use memory space. The memory must be erased in order to release memory used by deleted records.

If the Erase (F2) key is pressed, a prompt is shown below. To erase the memory press

✓ button (F4).

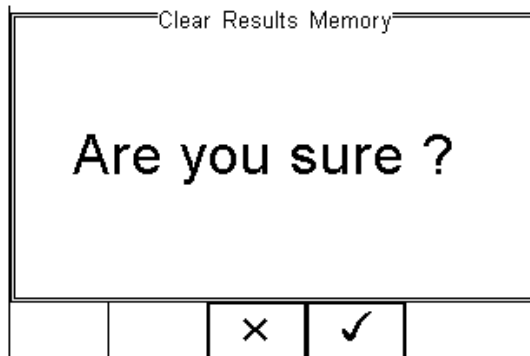

3.8. Restore Factory Settings

The factory settings can be restored at any time using this function. Press  button (F4). Select Setup followed by Restore Factory Settings.

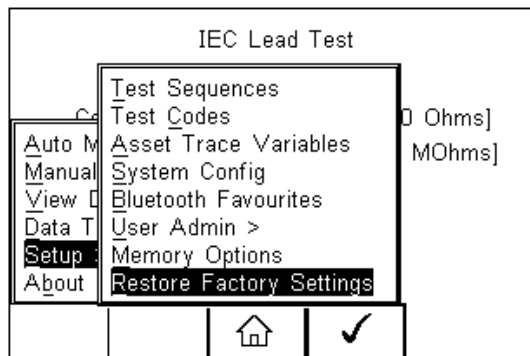

All the settings provided within the Setup menu will default to Factory Settings including; All Asset Trace Variables, Test Sequences, User Admin, Test Codes and System Config.

Warning: Restore Factory Settings cannot be undone and will remove all the customised items described above.



All customised settings within Setup can be cloned to a PC. We advise that this is done on a regular basis to ensure custom settings are saved for back-up. See 7.4 for further details on Cloning.

4. Automatic Mode

The Automatic mode provides the user with the ability to run a preset test sequence and store the data afterwards.

4.1. Asset ID

Each test record is stored using the Asset ID number (25 character max) and date / time of test. Multiple entries can be applied using the same Asset ID number. In this case, the memory will hold all entries and differentiate using the test date.



The Asset ID field is used to store (and identify) the record in the Rigel 288 database. Additional input fields, referred to as ASSET TRACE VARIABLES are available to distinguish between identical Asset ID records, ie when the ASSET ID field is used to enter the Model or 4 digit fast code. The benefit of using the Rigel 288 in this way is that similar items can be easily retested using the same parameters. When an existing ASSET ID is entered in the 288, the tester will automatically configure itself to re-perform the test without any additional settings being required. By using ASSET TRACE VARIABLES, each ASSET can be given a unique identifier in the database ie through the use of a serial number. A representation is provided below;

Asset ID (database record)	Asset Trace Variables							
	Service code	Site	Location	Make	Model	Description	Serial Number	Client
001	PPM	Site 1	Loc 1	JBM	X3000	ECG	1234er	NHS
001	PPM	Site 1	Loc 1	JBM	X3000	ECG	5678ty	NHS
001	PPM	Site 1	Loc 1	JBM	X3000	ECG	0986gh	NHS

Identical ASSET RECORDS are also differentiated by TIME/DATE stamp, thus ensuring no records are overwritten.

4.2. Test Codes

Efficiency is increased by using the 4-digit Test Codes which allow the user to group certain Test Sequences with Applied Part Configurations. See 3.2 more information on Test Codes.)

Test Sequence

The Rigel 288 comes standard with preset test routines to meet the requirements of:

- IEC 60601-1
- IEC 62353

-
- AAMi (US version)
 - NFPA-99 (US version)
 - VDE 0701 / 0702
 - IEC 61010 test sequences can be programmed. See Appendix G for available application notes.



In addition, the user can create a total of 50 preset test sequences to meet local or specific requirements. (See 3.1 more information on creating new test sequences)

4.3. Test Period

The re-test period allows the user to include the next test date on printed labels and PC downloads that make it easier to schedule future work. More details on printing labels see 4.2)

4.4. Trace Variables

To increase the traceability of the safety test, the user can include valuable data with the test record such as Re-test period and Asset variables (see 3.3, 3.4.1 and 4.1 for more information)

4.5. Performing an Automatic Test:

The automatic mode provides an option to test in full automatic or semi autoatic mode. In full automatic mode, the Rigel 288 will step through the non powered tests and once the powered tests (load and leakage tests) have started, all test conditions including single fault conditions are executed automatically without the required intervention of an operator.



See Application notes for suggestions when testing on isolated mains supply or fixed installations.

4.5.1. Semi Automatic Test Mode

When testing Medical Devices, it is important that measurements are taken when the Equipment Under Test (EUT) is fully operational (a requirement of IEC 60601-1 and subsequent standards).



The Rigel 288 has a unique Semi Automatic Mode that allows manual control of power-up and power-down of the EUT as well as controlling the test sequence. This ensures that correct measurements are performed and provide sufficient time to power-down any device which is sensitive to power-breaks e.g. Ultrasound Equipment and PC based ME Equipment.

Below is a graph highlighting the Grouping of Single Fault Conditions () and the delays which are manually controlled by the User (t_a , t_b , t_c & t_d) and the time in which the safety analyser performs the automatic test routines.

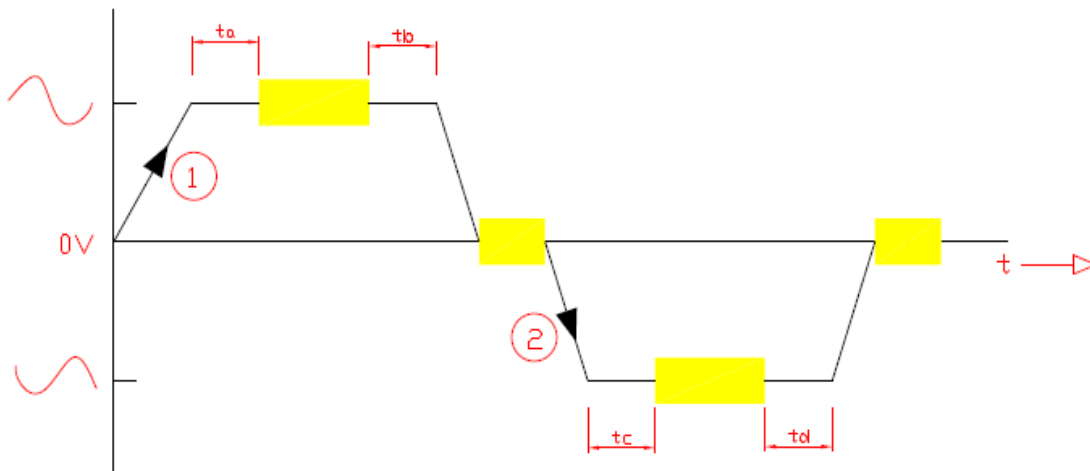

4.5.2. Failure Menu

When a specific test fails, the user will be provided with a number of options depending on the nature of the fault. The Failure Menu will enable the user to:

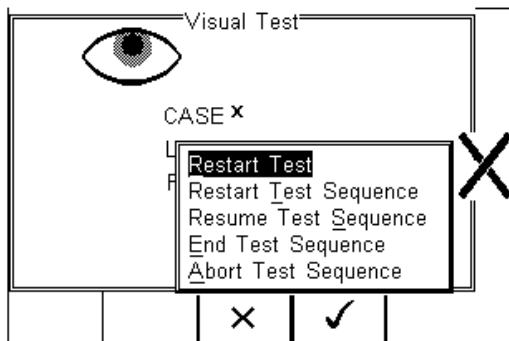

- Restart Test (Individual test)
- Restart Test Sequence (Whole Test sequence)
- Resume Test (Skip the failed test)
- End Test Sequence (store result and follow options. See 4.3)
- Abort Test Sequence (no information stored, return to home screen)

The following procedures describe the setup and completion of an automatic test sequence. The steps are applicable to all available test sequences. As example we describe a typical automatic test to IEC 60601.

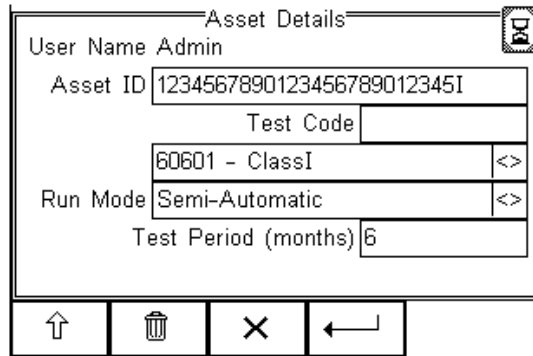

Press the  button (F4) from the home screen and select Auto Mode. This will show the Asset Details screen as detailed below;

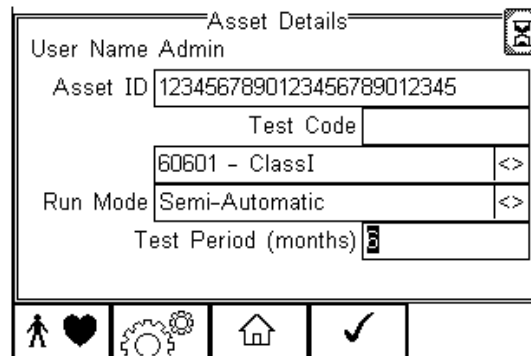

Select the right criteria for the Safety Test from the Asset Details screen;

1. Enter the Asset ID number using the keypad or barcode scanner.
2. Enter the Test Code if this has been created (see 3.2)
3. Use the up, down, left and right keys to select the required Test Sequence
4. Select the Run Mode (Semi or Full Automatic) using the up, down, left and right keys.
5. Enter the required test period in months.



6. Configure the Applied Part module when required by pressing the   button (F1).

The following screen presents a default setup for:

10 x type CF (1..10)

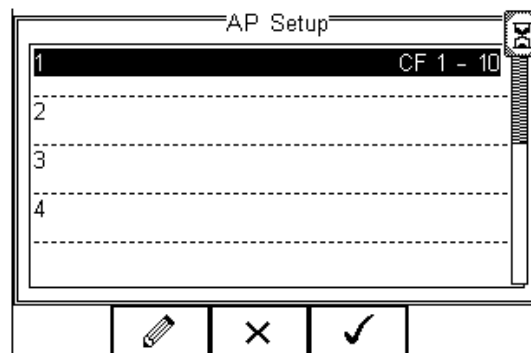

To configure the Applied Part Module to meet your requirements, please see 3.2.2 for more information.



When the configuration has been completed, press the  button (F4).

Pressing the  button (F3) would return to the previous screen and lose the settings.

7. Returning to the Asset Details screen, the  button (F2) provides the user with the option to modify or create a new Test Sequence from this menu. This feature is identical to that of the Test Sequence feature in the Setup - Test Sequence menu. (See 3.1 for more information)

When all parameters are set, press the  button (4) to enter the Asset Trace Variables screen (when applicable). In this example, all Asset Variables are activated.

Asset Trace Variables	
Service Code	ABC
Site	Site 1 <>
Location	LOCATION1 <>
Make	DG Medical <>
Model	JB4000 <>
Description	Patient Monitor <>
Serial Number	07W10L3M <>
Client	Durham NHS <>

8. Use the Up & Down Keys to navigate the menu and the Left & Right Keys to open the drop down boxes [<>]. Select the required input and confirm with the  button (F4). Each variable entered during the automatic test will automatically be added to the list for future use. Trace Variables that are deactivated (set to NO in the Setup menu, section 3.3) will not appear during the automatic tests.



A maximum of 40 individual entries are available for each Trace Variable. Additional entries will overwrite on a first in first out basis.

When all information is provided, press the  button (F4) to start the safety test.

To ensure the safety of the user, non-electrical tests are done prior to the powered electrical safety tests.

Non-powered tests are deemed;

- Visual and Custom tests (if applicable),
- Earthbond test (class I)
- Insulation test (if applicable)

In this example we will perform a safety test on Class I equipment, using a preset test sequence, based on IEC 60601-1 with added Visual Test prior to the safety test and a Custom Test followin the successful safety test.

The Applied Part Configuration is set to default and the test is executed in Semi Automatic mode.

Visual Test

This is the first test in the test sequence;

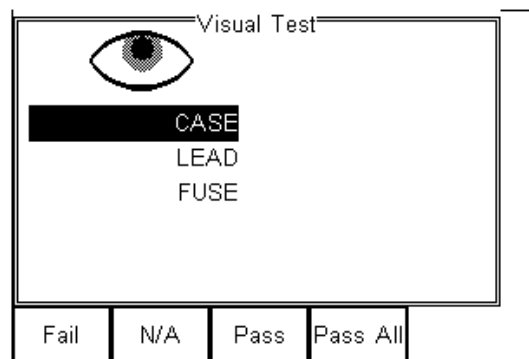

Press the corresponding appropriate button to select the outcome of the visual test.



Custom Visual tests can be created. See 3.1.5 for more information. If one or more Visual tests result in a failure, a Failure menu will appear.

Provided the test has Passed, the next test will be the Earth Continuity

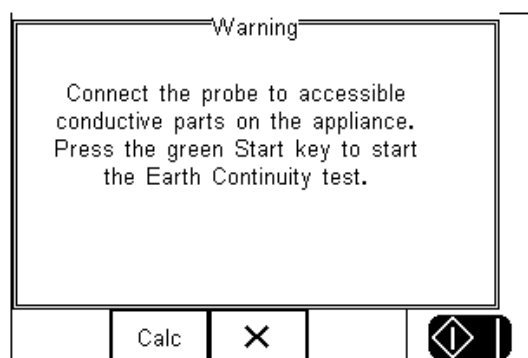

Attention! Ensure the earth bond test lead is connected to the green socket when testing between probe and EUT earth.

Press the Calc button (F2) to calculate the pass fail limit based on the type of cable (mm²) and cable length.

Pressing the **X** button (F3) will bring up the failure menu (see 4.1.2)

Press the Green start key to start the earth continuity test.

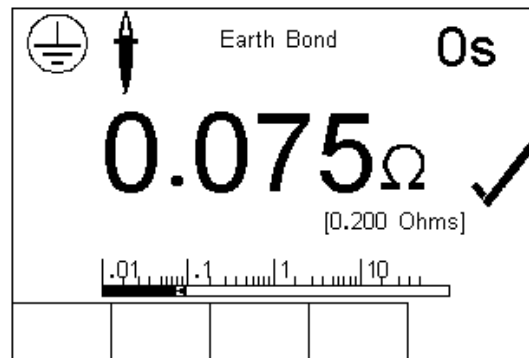

⚠ Caution, never connect the Earth Bond Probe to voltages in excess of 30V since this can cause damage to the equipment.

The earth bond test screen provides both a digital read-out as well as a bar-graph indication. In addition, the test duration (top right corner), limit ([0.200 Ohms]) and Tick mark are provided to demonstrate the test has passed.

If the test fails, the failure menu will be displayed. See 4.1.2

Once the non-powered tests have been completed, the user is warned that the EUT is about to be switched on.

⚠ Warning – never leave the earth bond, or any other probe attached to any moving parts.

⚠ Warning – never touch the appliance under test whilst testing is in progress. Doing so could result in injury due to electric shock and / or sudden movement of any mechanical parts on the appliance.

⚠ Refer to page 7 for notes on precautions required for compliance with the relevant safety standards.

⚠ Do not exceed the maximum permitted voltage of 30 V AC/DC with respect to earth potential! Electric Shock danger!

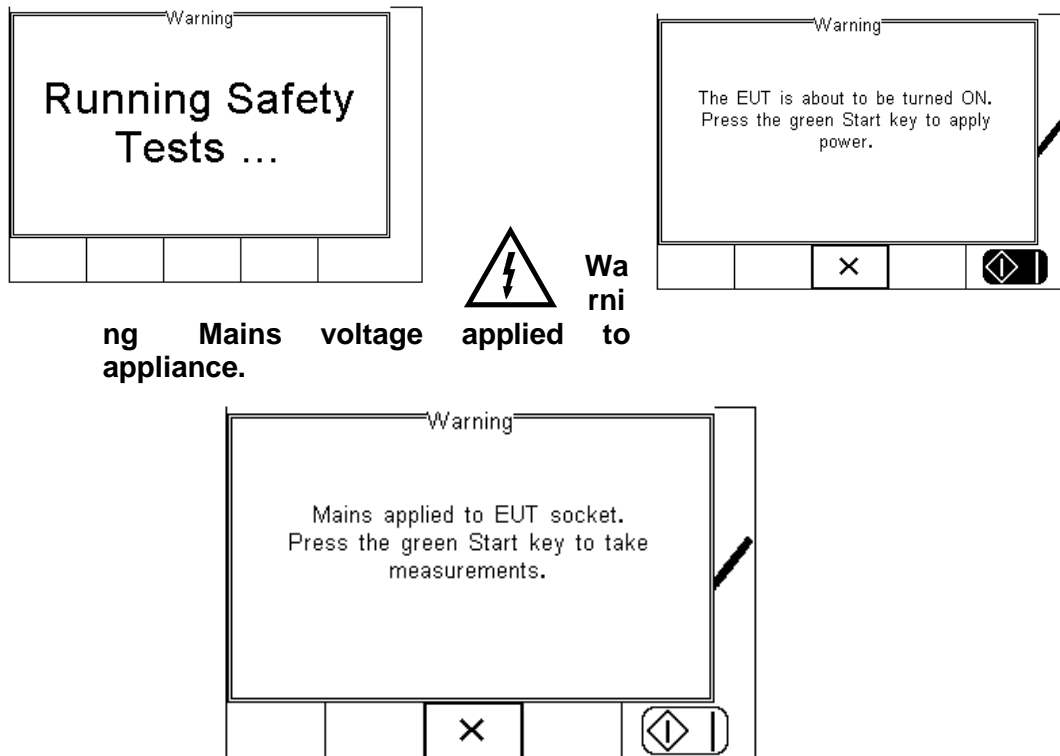

This example uses the Semi Automatic Mode and the user has the opportunity to determine the moment at which the leakage measurements start. In fully automatic mode, the Rigel 288 will start the measurements immediately after the EUT has been switched on.

The initial powered test is a load test. The Rigel 288 will check for a short circuit EUT and ensure the applied load (EUT) is less than 16 A.

In case of a short circuit in the EUT, the Rigel 288 will not power-up and a warning message is displayed.

Following the Load Test, the individual leakage tests are polled, displayed and measured.

Note that all leakage measurements are grouped by Single Fault Condition (SFC) As such, all leakage measurements are carried out for a specific SFC, leakage measurements are then repeated for the next SFC. This is to minimise the power breaks and power ups. By grouping the SFC's, the Rigel 288 is able to perform a full IEC 60601-1 test, only requiring two power breaks.

The sequence of Single Fault Conditions is;

1. **Normal Supply**
2. **Normal Supply Open Earth SFC** (for Class I equipment only),
3. **Normal Supply Open Neutral** (Power Break),
4. **Reversed Supply** (Power on),
5. **Reversed Supply Open Earth**, (for Class I equipment only),
6. **Reversed Supply Open Neutral** (Power Break)

The applicable SFC is displayed in the bottom left side of the display. The following is a typical sequence for a class 1 device.

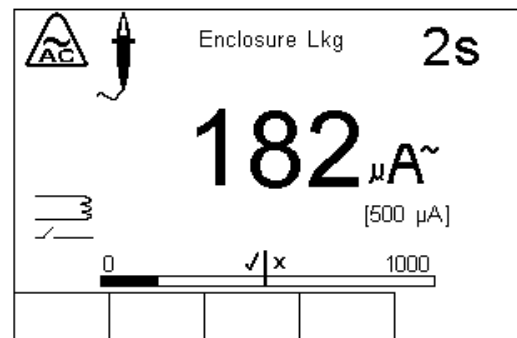
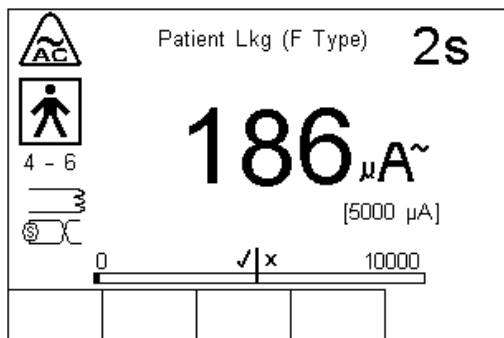
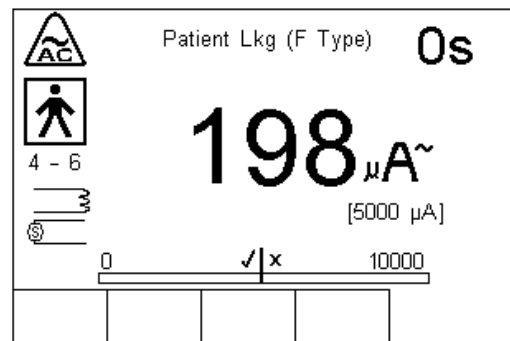
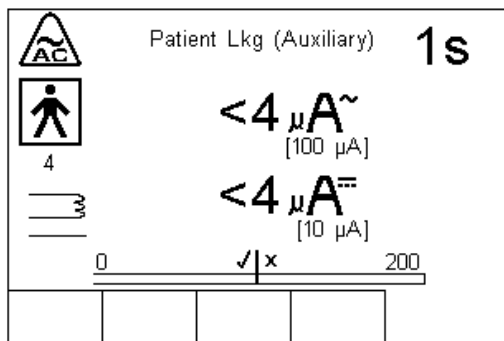
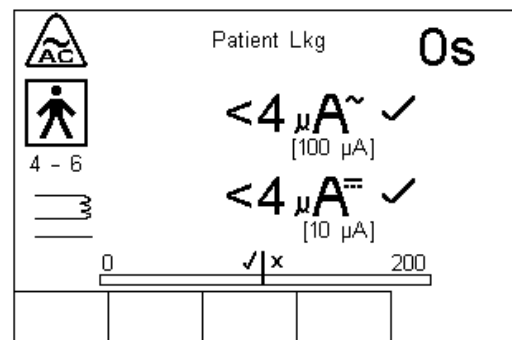
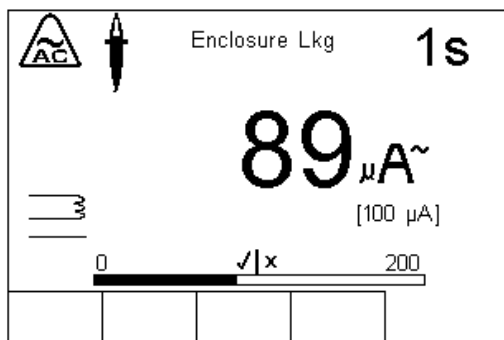
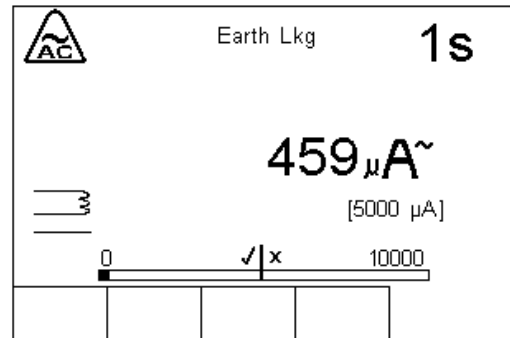
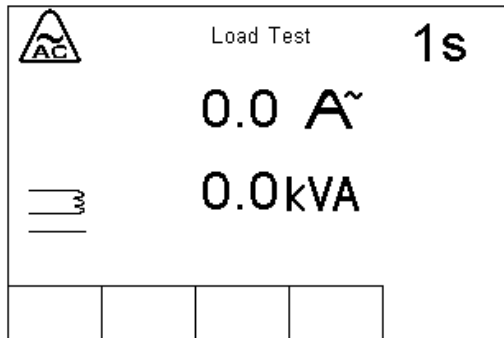

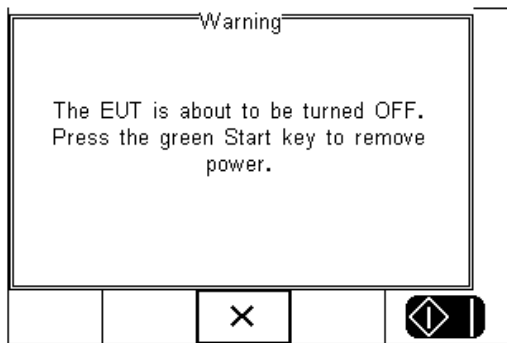
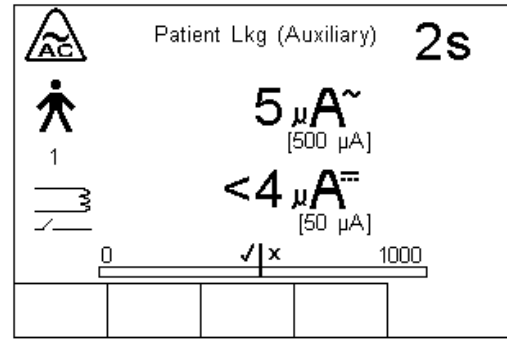
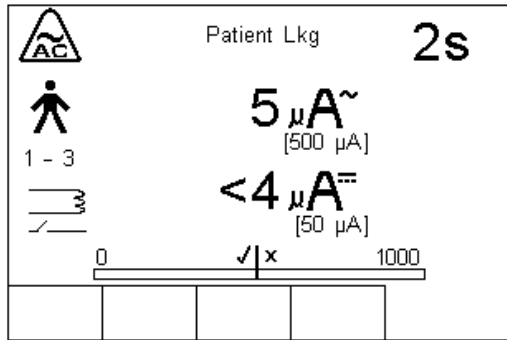

Now the test sequence requires to open the Neutral which will result in a power break. The Semi Automatic mode provides the user with a warning and requires a confirmation prior to interrupting the Neutral. This allows the user to properly power down the Medical Device and prevent possible damage caused by interrupting the power supply.

Note that this message is not available in full automatic mode. The Rigel 288 will continue with all warning open neutral measurements.

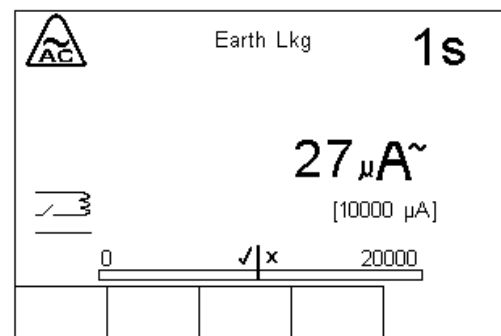
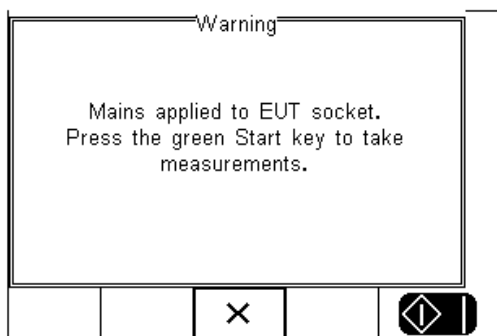

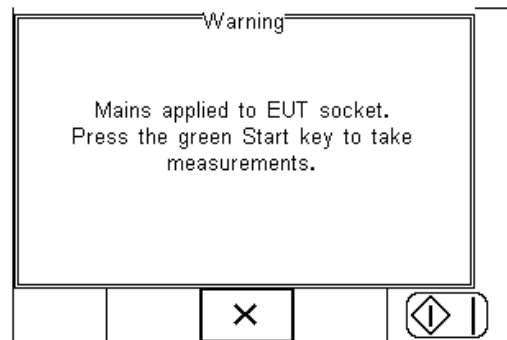
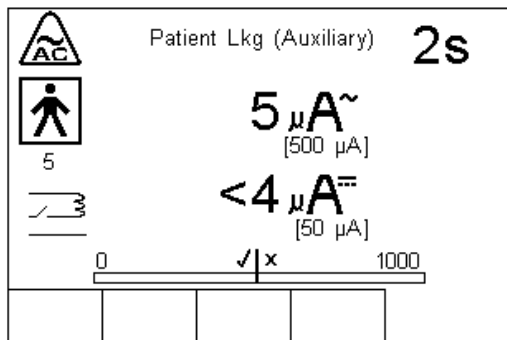
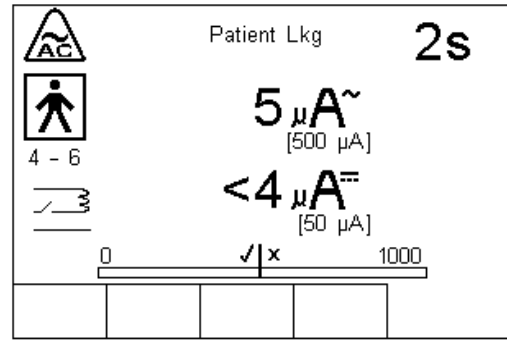
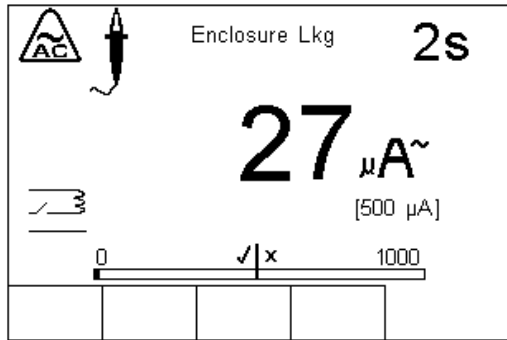

The next step is to reverse the power supply. The Rigel 288 will automatically reverse the power and start the test sequence again. In the semi automatic mode, the user can determine when the measurements start. In full automatic mode, the power reversal is instant and measurements will start directly after mains reversal.

Following the safety tests, the user is able to store additional information within the test record such as performance of the medical device. See 3.1.6 for more on creating non-electrical safety tests.

In this example we used a defib test. Simply enter the reading from the defibrillator tester in the field provided. Then determine whether the test has passed or failed.



Additional customer tests (each 255 characters max) can be added to the test program to provide a comprehensive test record combining visual tests with safety and performance tests.

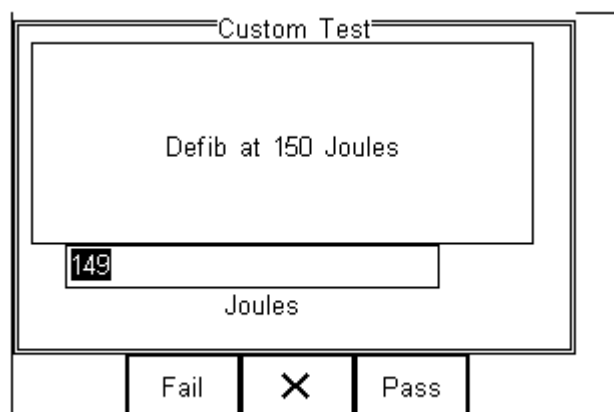

At the end of the test, the user has the ability to enter comments. See 3.4.3 for more information on how to activate comments after a test.

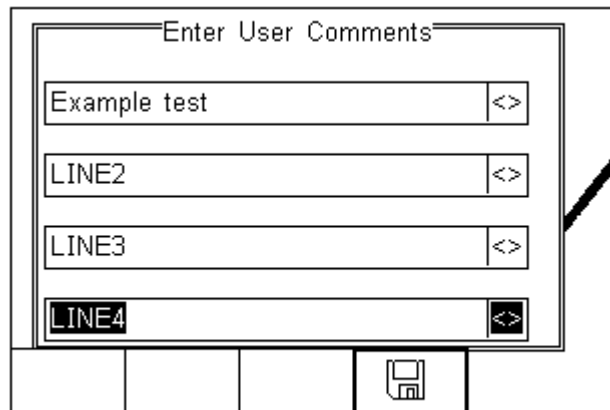

Press the  button (F4) to store the comments.

Depending on the settings in Menu - Setup - System Config (see 3.4.2) , a number of After Test options are possible;

- **New Test** – Automatically brings up the next test screen.
No further options or viewing of results available
- **Download** – Automatically down loads the test results to the PC (see 7.1)
No further options or viewing of results available. The tester will return to the home screen.
- **Print Label** – Automatically prints the test results to a thermal printer.
No further options or viewing of results available. The tester will return to the home screen.
- **Test 'n Tag** – Automatically prints a Test 'n Tag label. (see 4.2)
No further options or viewing of results available. The tester will return to the home screen.
- **Options Menu** – Provides a menu to allow further choices after a test. (see 4.3)

4.6. Test 'n Tag

The Rigel 288 is compatible with the Seaward Test 'n Tag and Test 'n tag Elite system To use the Test 'n Tag printer, add your T'nT printer to the Bluetooth Favorites. See 3.5



A detailed application note is available from the Rigel website on the used of Test' n Tag printers with the Rigel 288.

Please visit; <http://www.rigelmedical.com/knowledgebase/>

4.7. Options Menu

When Options has been selected in the Setup - System Config menu, the Rigel 288 will show a Test Details screen, see below.

Test Details	
Asset ID	1234567890
Tested by	Admin
Tested on	23 Jan 2007 11:23 AM
Mode	Semi-Auto...
Status	Failed
Test Period (months)	6

🏠 ↻ →☰

The test screen provides the following features;

- Go to the home screen (F1)
- Continue with the next test (F2)
- Options (F3)

To view the options menu, select the →☰ button (F4) from the test details screen; The options menu provides the following sub menu:

Test Details	
Asset ID	1234567890
Tested by	Admin
Tested on	23 Jan 2007 11:23 AM
Mode	Semi-Auto...
Status	Failed
Test Period (months)	6

View Results
User Comment
Print Label
Print Result
Test'n'Tag

✕ ✓

View Results will display the results of the test (see section 4.8)

User Comment will allow the user to enter comments if required

Print Label will print a pass/fail label on the thermal printer (50 mm roll)

Print Result will print the result on the thermal printer (50 mm roll)

Test 'n Tag will produce a thermal transfer Pass Fail label. (see 4.6)

4.8. View Results

View Test Results	
Patient Lkg	Pass
6 μ A AC	[50 μ A]
Connection 7, 7-10 CF	E - R -

Patient Lkg	Pass
6 μ A AC	[500 μ A]
Connection 1-3 B	- N R -

← →☰

Use the ← button (F2) to return to the Test Details screen. The →☰ button (F4) provides extra option to print results, label or Test 'n tag

5. Manual Mode

The Manual mode provides the user with the features of testing a specific individual test and or test condition for example to aid fault diagnostic procedures. Manual tests are available from the home screen. Use the Left & Right Keys to scroll through the various manual tests.

Manual tests can also be chosen, by pressing the  button (F4) and select Manual Mode from the list. See below.

 **Do not connect any probe combination to voltages in excess of 30 V AC/DC with respect to earth potential when performing non-power tests. This can cause damage to the equipment.**

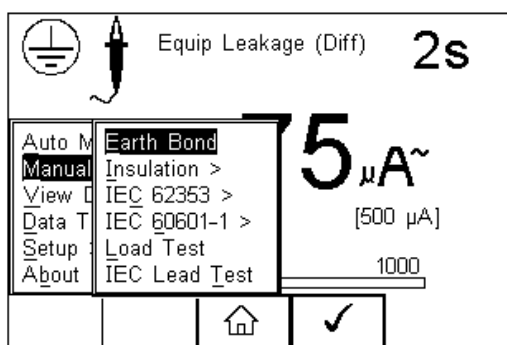

Below is a map showing where the individual tests can be selected in the Manual Mode menu.

Manual Mode > *Earth Bond*

Insulation > **Insulation EUT**
 Insulation AP
 Insulation AP to mains

IEC 62353 > **Equipment Leakage >** Direct
 Alternative
 Differential

AP Leakage Test > Direct
 Alternative

IEC 60601-1> **Earth leakage**
 Enclosure Leakage
 Patient Leakage
 Patient Lkg (Auxiliary)
 Patient Lkg (F-Type)

Load test

IEC lead test

For example; To select an IEC 62353 - Equipment Leakage - Direct Method;

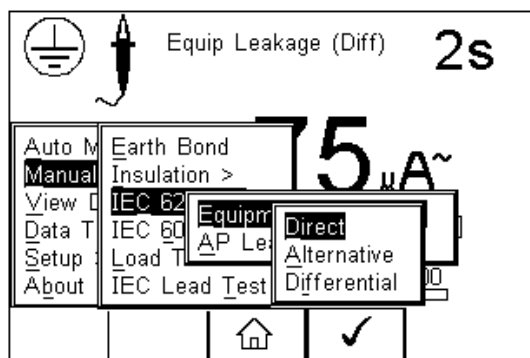

Use the Up, Down, Left and Right keys to navigate through the menu and press the  button (F4) to confirm.

The following manual mode screen appears;

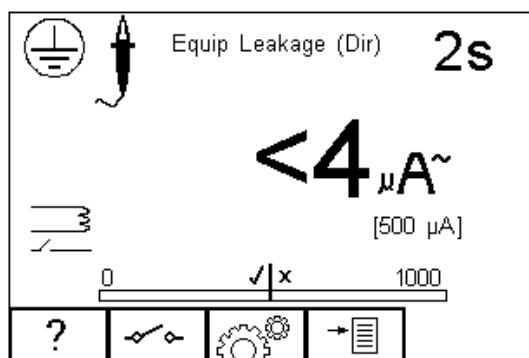



The centre of the analogue bargraph indicates the limit value (in this case 500μA)

 **Warning, during many of the leakage tests the PROTECTIVE EARTH CONDUCTOR to the appliance under test is interrupted. For this reason additional means of protection are required in order to comply with the relevant safety standards. For EN60601-1 leakage tests, it is recommended that this additional protection is in the form of an isolation transformer, with an isolated reference ground, used to power the entire system.**

The screen shows the current measuring condition, ie;

- Equipment Leakage (Direct Method)
- 2 second test duration
- limit is [500μA]
- Single Fault Condition (normal polarity – open earth)*
- Class 1 and enclosure probe symbol

* The IEC 62353 specifies that the Direct Method measurement is done using an interrupted earth. The  button (F2) will only reverse the power supply.

All manual tests can be modified to meet user requirements. To change the settings in the manual mode, simply press the  button (F3).

Help is available by pressing the  button (F1) in the form of a schematic representation of the test.

Depending of the type of test, the F2 key is either used to select the test class (Class I or II) or to set the single fault conditions. In the latter case, the test class can be set within the  menu button (F3).

5.1.1. Earth Continuity

This test is applicable to Class I equipment only.

Press the F1  button to obtain the schematic representation of this test:

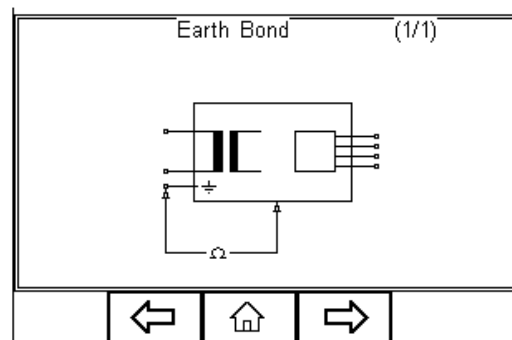
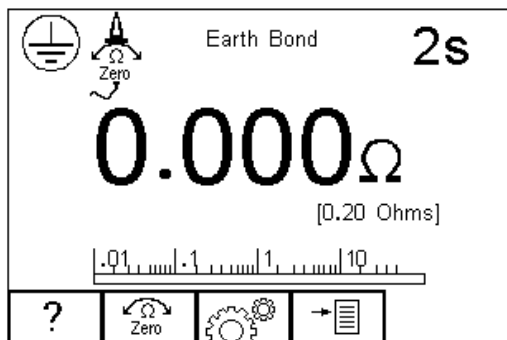



If an earth bond lead other than that supplied with the Rigel 288 is to be used then any resistance associated with this lead can be zeroed out by connecting the supplied earth bond lead to the EUT earth socket on the Rigel 288 and pressing the zero button (F2). If the zero function has been activated then the zero icon overwrites the single probe icon in the top left of the display. By preventing the zero button (F2) again this function is cancelled.

 **Do not exceed the maximum permitted voltage of 30 V AC/DC with respect to earth potential! Electric Shock danger!**

This test will check that the connection between the earth pin in the mains plug of the appliance and the metal casing of the appliance is satisfactory and of sufficiently low resistance.

A DC test current of $\pm 200\text{mA}$ is applied between the earth pin of the mains supply plug and the earth bond test lead clip/probe. The worst-case result is shown on the display.

Press  button (F3) to set the Test Duration and Pass/Fail limit. Use the up, down, left and right keys to highlight, set, test duration and pass/fail limit. The pass/fail limit can be calculated whilst in this mode by pressing (Calc) (F3). Enter the cross sectional area and length of cable and a new limit will be calculated. This can be

overridden by selecting the continuity limit from the list. Press  button (F4) when complete.  button (F3) will exit Settings mode without saving changes.



Switching off the Rigel 288 will not cancel the 'probe zero'

Fit the Appliance mains plug into the EUT socket. Connect the Earth Bond lead to the appliance metal part. Press the green **START** key to begin the test. The test will run for a preset test duration. To end the test before the test time expires press the red **STOP** key.

This test can also be used to test the earth bond resistance within an IEC power lead. Connect the IEC power lead between the EUT power socket and IEC socket on the rear panel of the Rigel 288 and commence the test.





The Rigel 288 display will show real time measurements during an Earth Continuity test however, the highest reading is recorded during the test. This can be used to detect momentary break in the earth path e.g. damaged power cords or loose mains plug connections. A Pass or Fail is determined by comparing the peak value measured during the test with the pre-set continuity limit.

5.1.2. Insulation Resistance EUT

This test is applicable to all Class I and Class II equipment, typically used as part of MDA DB 9801 and IEC 62353 test routines.

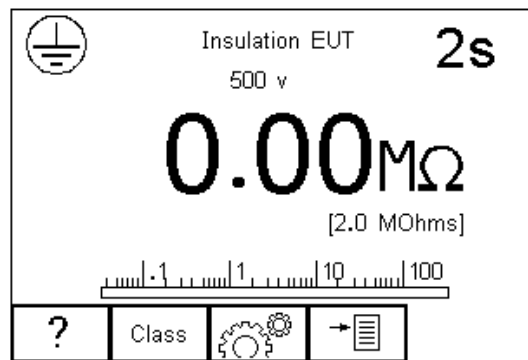
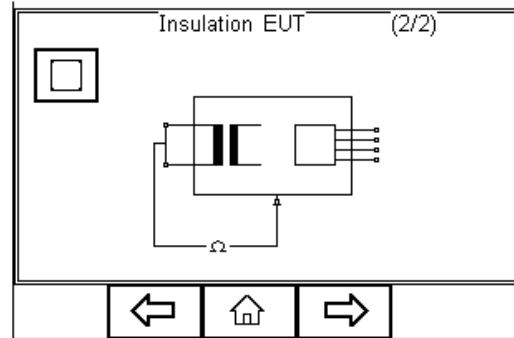
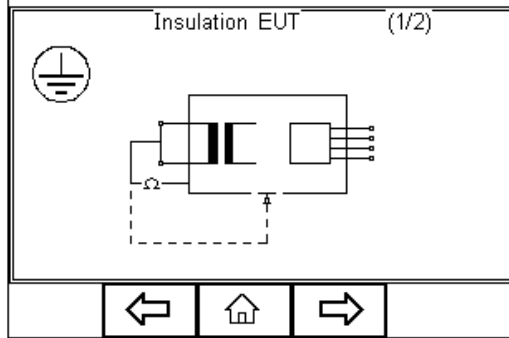
Press the F1  button to obtain the schematic representation of this test:





 **Do not exceed the maximum permitted voltage of 30 V AC/DC with respect to earth potential! Electric Shock danger!**

This test is used to verify that the mains supply pins are adequately insulated from earth (Class I) or the enclosure (Class II).

 **During this test, 500V D.C. is applied between the earth pin and both the live and neutral pins of the appliance mains supply plug.**

Press  button (F3) to set the Test Duration, Insulation test voltage (500 / 250VDC) and Pass/Fail limit. Use the up, down, left and right keys to highlight and set.

Press  button (F4) when complete. Pressing  button (F3) will exit Settings mode without saving changes.

Press the class button (F2) to set the class of the appliance under test. For a class II appliance the probe symbol will be displayed at the top of the LCD display.

For both Class 1 and Class II appliances fit the Appliance mains plug into the EUT socket. For Class 2 appliances only connect the Earth Bond lead to the appliance. Press the green START key to begin the test. The test will run for the duration set or until the red STOP key is pressed.

5.1.3. Insulation Resistance Applied Parts

This test is applicable to Class I and Class II BF and CF equipment only, typically used as part of MDA DB 9801 and IEC 62353 test routines.

Press the F1  button to obtain the schematic representation of this test:

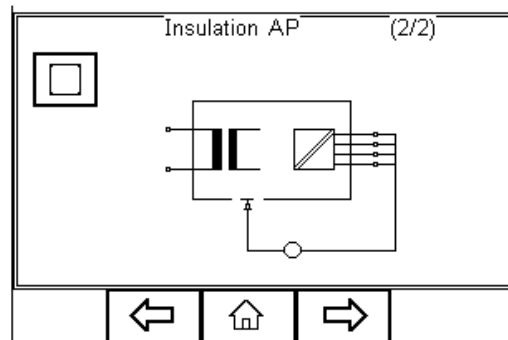
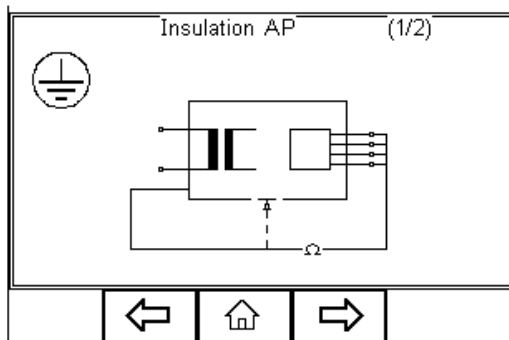
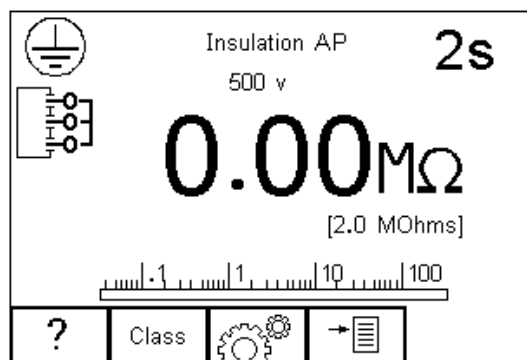



 **Do not exceed the maximum permitted voltage of 30 V AC/DC with respect to earth potential! Electric Shock danger.**

This test is used to verify that the Applied Parts are adequately insulated from earth (Class I) or the enclosure (Class II).

 **During this test, 500V D.C. is applied between the earth pin (Class I) or the enclosure (Class II) and all the Applied Parts combined.**

Press  button (F3) to set the Test Duration, Insulation test voltage (500 / 250VDC) and Pass/Fail limit. Use the up, down, left and right keys to highlight and set.

Press the  button (F4) when complete. Pressing the  button (F3) will exit the Settings mode without saving changes.

Press the class button (F2) to set the class of the appliance under test. For a class II appliance the probe symbol will be displayed at the top of the LCD display.

For both Class 1 and Class II appliances, connect the Patient Connections or Applied Parts to the Applied Part Module and fit the Appliance mains plug into the EUT outlet. For Class 2 appliances only connect the Earth Bond lead to the appliance. Press the green START key to begin the test. The test will run for the duration set or until the red STOP key is pressed.

5.1.4. Insulation Resistance Applied Parts to Mains

This test is applicable to Class I and Class II BF and CF equipment only, typically used as part of IEC 62353 test routines.

Press the F1  button to obtain the schematic representation of this test:

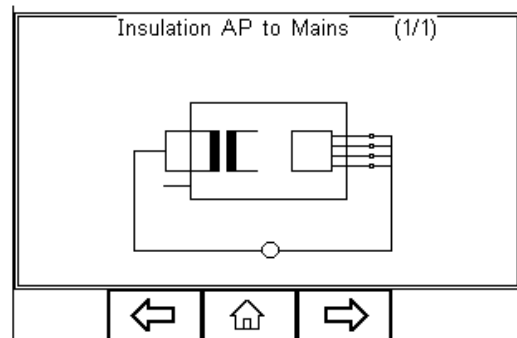
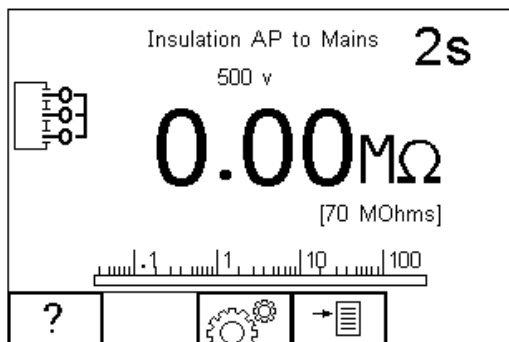



 **Do not exceed the maximum permitted voltage of 30 V AC/DC with respect to earth potential! Electric Shock danger.**

This test is used to verify that the Applied Parts are adequately insulated from the mains parts.

 **During this test, 500V D.C. is applied between all the Applied Parts combined and both the live and neutral pins of the appliance mains supply plug.**

Press  button (F3) to set the Test Duration, Insulation test voltage (500 / 250VDC) and Pass/Fail limit. Use the up, down, left and right keys to highlight and set.

Press the  button (F4) when complete. Pressing the  button (F3) will exit Settings mode without saving changes.

For both Class 1 and Class II appliances, connect the Patient Connections or Applied Parts to the Applied Part Module and fit the Appliance mains plug into the EUT outlet.

Press the green START key to begin the test. The test will run for the duration set or until the red STOP key is pressed.



5.1.5. Equipment Leakage (Direct)

The Equipment Leakage Test measures the total leakage deriving from the Applied Parts, Enclosure and Mains Parts combined to real earth.

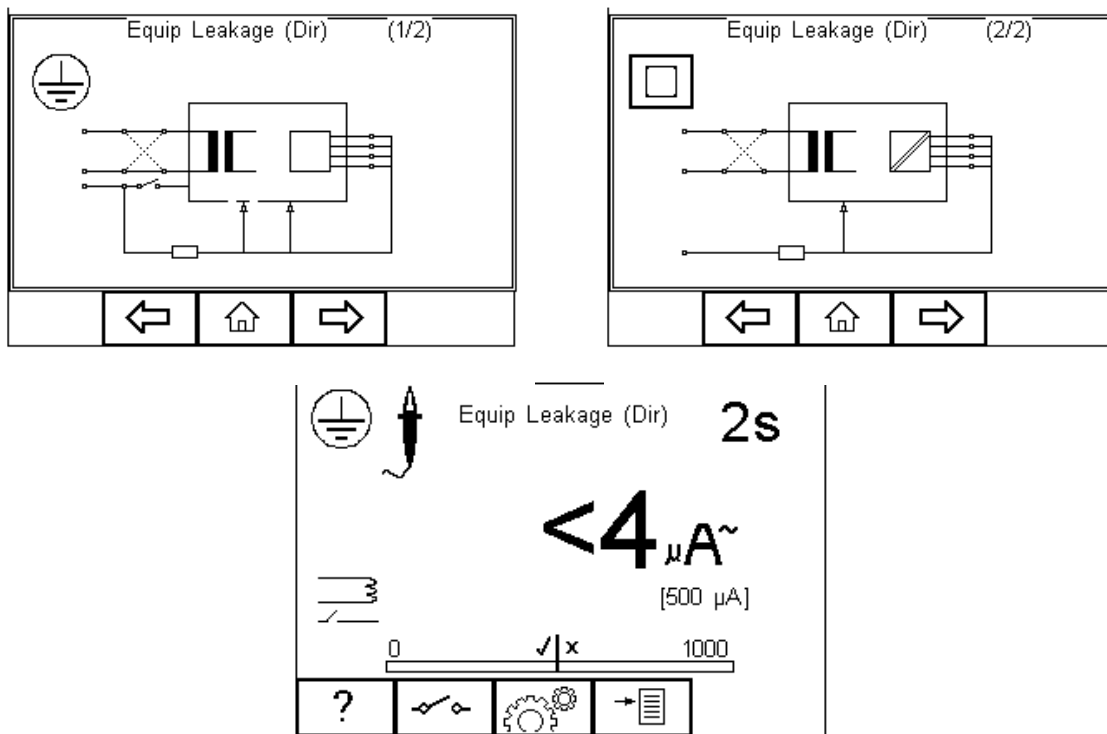

This test is applicable to Class I and Class II B, BF and CF equipment. This is an IEC 62353 test. For a complete description of this test and applicable pass / fail limits, please see Appendix C & D.

Press the  button (F1) to obtain the schematic representation of this test:



-  **Warning – never leave the earth bond, or any other probe attached to any moving parts.**
-  **Warning – never touch the appliance under test whilst testing is in progress. Doing so could result in injury due to electric shock and / or sudden movement of any mechanical parts on the appliance.**
-  **Refer to page 7 for notes on precautions required for compliance with the relevant safety standards.**

 **Do not exceed the maximum permitted voltage of 30 V AC/DC with respect to earth potential! Electric Shock danger!**

Press  button (F3) to set the Test Duration, and RMS Pass/Fail limit. Use the arrow keys to highlight and set. Press the  button (F4) when complete. Pressing the  button (F3) will exit Settings mode without saving changes.

Press the  button (F2) to change the mains polarity.

For both Class 1 and Class II appliances, connect ALL* Patient Connections or Applied Parts to the Applied Part Module and fit the Appliance mains plug into the EUT outlet.



All Patient Connections and Applied Parts are grouped together which eliminates the requirement to configure the Applied Part Module as the Rigel 288 will short together all 10 connections as part of this test. For this reason, the Applied Part configuration key is not available.

For Class I equipment use the earth bond lead (from the green socket) and connect to a conductive part of the enclosure. For measurements on conductive non-earthed parts, the test needs to be repeated using the same probe.

For Class II devices use the earth bond lead (from the green socket) and connect to the enclosure preferably encapsulated within conductive foil.

Press the green START key to begin the test. The test will run for the duration set or until the red STOP key is pressed.

5.1.6. Equipment Leakage (Differential)

The Equipment Leakage Test measures the total leakage deriving from the Applied Parts, Enclosure and Mains Parts combined to real earth.

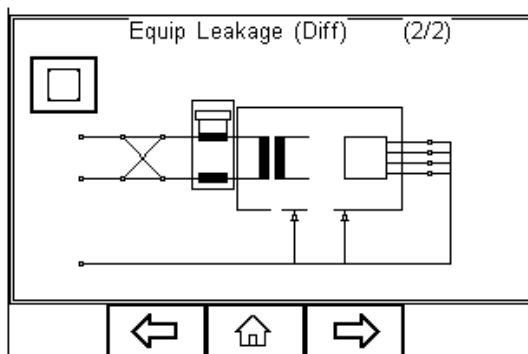
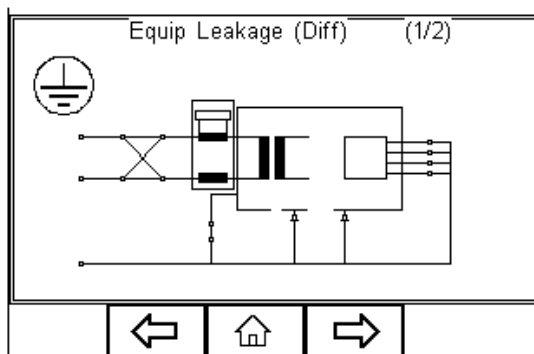

This test is applicable to Class I and Class II B, BF and CF equipment. This is an IEC 62353 test. For a complete description of this test and applicable pass / fail limits, please see Appendix C & D.

Press the  button (F1) to obtain the schematic representation of this test:

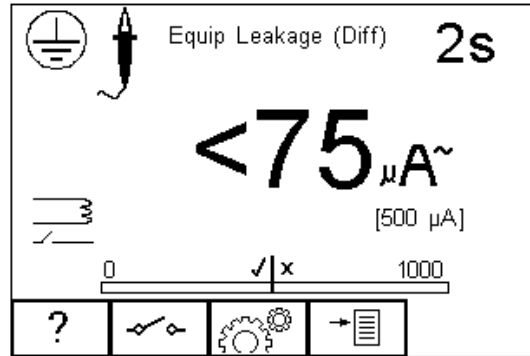



- ⚠ **Warning – never leave the earth bond, or any other probe attached to any moving parts.**
- ⚠ **Warning – never touch the appliance under test whilst testing is in progress. Doing so could result in injury due to electric shock and / or sudden movement of any mechanical parts on the appliance.**
- ⚠ **Refer to page 7 for notes on precautions required for compliance with the relevant safety standards.**
- ⚠ **Do not exceed the maximum permitted voltage of 30 V AC/DC with respect to earth potential! Electric Shock danger!**

Press  button (F3) to set the Test Duration, and RMS Pass/Fail limit. Use the arrow keys to highlight and set. Press the  button (F4) when complete. Pressing the  button (F3) will exit Settings mode without saving changes.

Press the  button (F2) to change the mains polarity.

For both Class 1 and Class II appliances, connect ALL Patient Connections or Applied Parts to the Applied Part Module and fit the Appliance mains plug into the EUT outlet.



All Patient Connections and Applied Parts are grouped together which eliminates the requirement to configure the Applied Part Module since the Rigel 288 will short all 10 connections together as part of this test. For this reason, the Applied Part configuration key is not available.

For Class I equipment use the earth bond lead (from the green socket) and connect to a conductive part of the enclosure. For measurements on conductive non-earthed parts, the test needs to be repeated using the same probe.

For Class II devices use the earth bond lead (from the green socket) and connect to the enclosure preferably encapsulated within conductive foil.

Press the green START key to begin the test. The test will run for the duration set or until the red STOP key is pressed.

5.1.7. Equipment Leakage (Alternative)



This method is similar to the dielectric test between the mains parts shorted together and the Applied Parts/accessible parts (conductive and non-conductive) connected together.

This test is applicable to Class I and Class II B, BF and CF equipment. This is an IEC 62353 test. For a complete description of this test and applicable pass / fail limits, please see Appendix C & D.

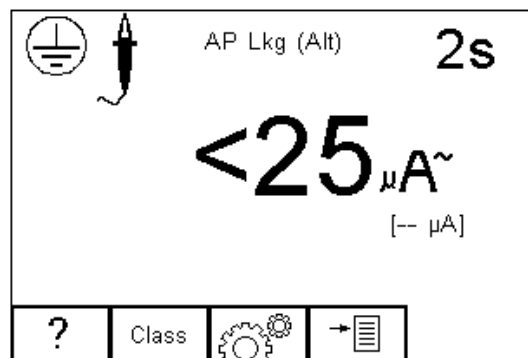
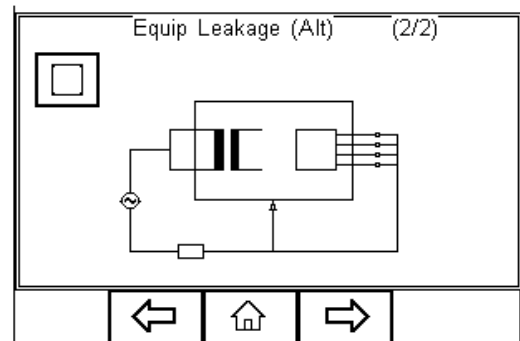
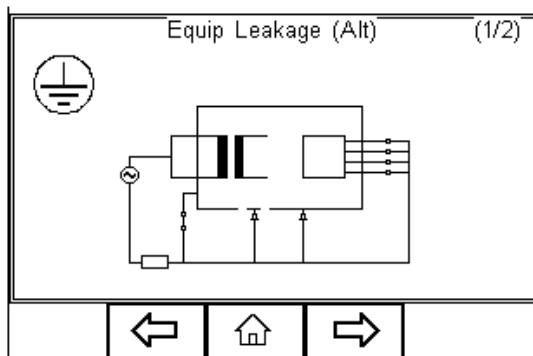
Press the  button (F1) to obtain the schematic representation of this test:



Press  button (F3) to set the Test Duration, Insulation test voltage (500 / 250VDC) and Pass/Fail limit. Use the up, down, left and right keys to highlight and set.

Press  button (F4) when complete. Pressing  button (F3) will exit Settings mode without saving changes.

For both Class 1 and Class II appliances, connect ALL Patient Connections or Applied Parts to the Applied Part Module and fit the Appliance mains plug into the EUT outlet.



All Patient Connections and Applied Parts are grouped together which eliminates the requirement to configure the Applied Part Module as the Rigel 288 will short together all 10 connections as part of this test. For this reason, the Applied Part configuration key is not available.

For Class I equipment use the earth bond lead (from the green socket) and connect to a conductive part of the enclosure. For measurements on conductive non-earthed parts, the test needs to be repeated using the same probe.

For Class II devices use the earth bond lead (from the green socket) and connect to the enclosure preferably encapsulated within conductive foil.

Press the green START key to begin the test. The test will run for the duration set or until the red STOP key is pressed.

5.1.8. Applied Part Leakage (Direct)

The Applied Part Leakage Test measures the total leakage deriving from the combined Patient Connections within an Applied Part to earth and any conductive or non conductive parts on the enclosure (either connected or isolated from earth) under the fault condition Mains on Applied Parts.

The Applied Part Leakage Test is applicable to class I and class II floating type (BF & CF) Applied Parts. This is an IEC 62353 test. For a complete description of this test and applicable pass / fail limits, please see Appendix C & D.

Press the  button (F1) to obtain the schematic representation of this test:

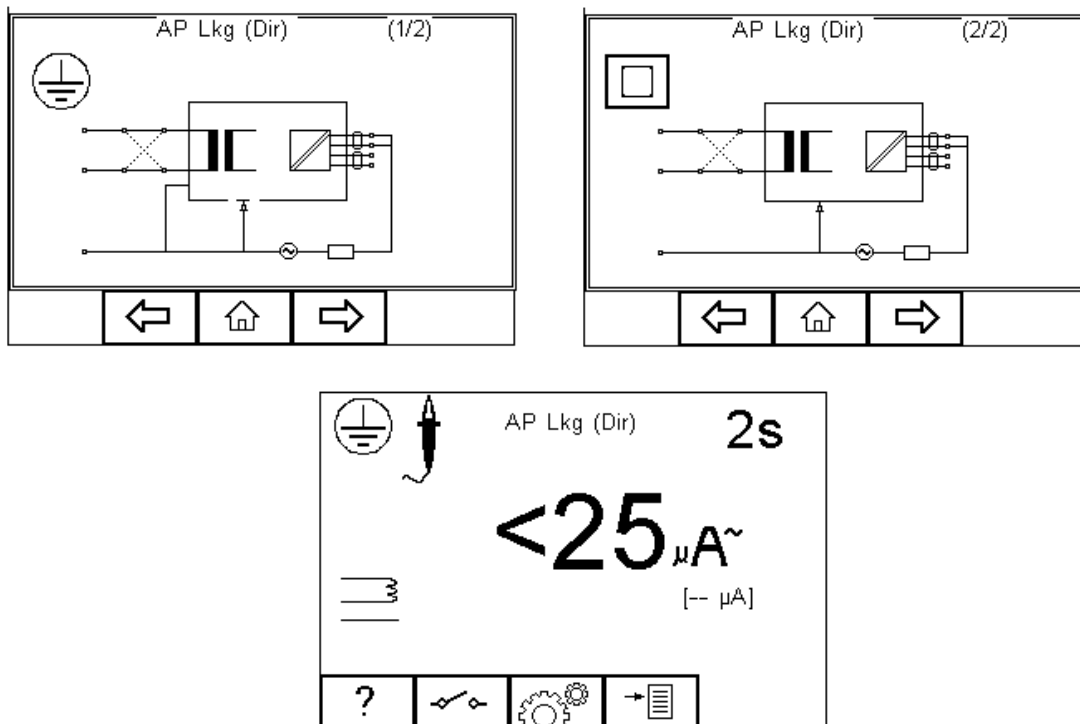





 **Warning – never leave the earth bond, or any other probe attached to any moving parts.**

 **Warning – never touch the appliance under test whilst testing is in progress. Doing so could result in injury due to electric shock and / or sudden movement of any mechanical parts on the appliance.**

 Refer to page 7 for notes on precautions required for compliance with the relevant safety standards.

 Do not exceed the maximum permitted voltage of 30 V AC/DC with respect to earth potential! Electric Shock danger!

Press the  button (F2) to change the mains polarity.

Press  button (F3) to set the Test Duration, Equipment Class, Applied Part module and RMS Pass/Fail limit for BF and CF Applied Parts. Use the up, down, left and right keys to highlight and set. Press  (F4) when complete. Pressing the  button (F3) will exit Settings mode without saving changes.

To configure the Applied Part Module press the  button (F1) in the Settings menu. For instructions on using this feature, see 3.2.2

For both Class 1 and Class II appliances, connect the Patient Connections or Applied Parts to the Applied Part Module as per the configuration above.



For Class I equipment use the earth bond lead (from the green socket) and connect to a conductive non-earthed part.

For Class II devices use the earth bond lead (from the green socket) and connect to the enclosure preferably encapsulated within conductive foil.

Press the green START key to begin the test. The test will run for the duration set or until the red STOP key is pressed.



5.1.9. Applied Part Leakage (Alternative)

This method is similar to a dielectric test between the Applied Part and all mains parts, EUT earth and Enclosure connected together.

The Applied Part Leakage Test is applicable to Class I and Class II floating type (BF & CF) Applied Parts. This is an IEC 62353 test. For a complete description of this test and applicable pass / fail limits, please see Appendix C & D.

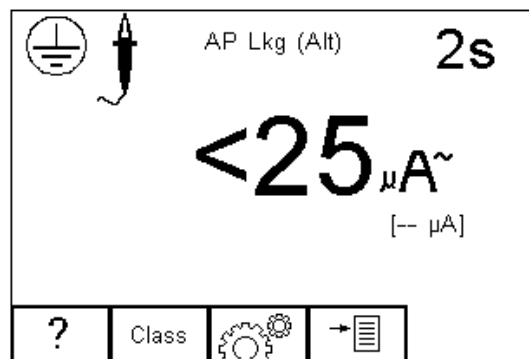
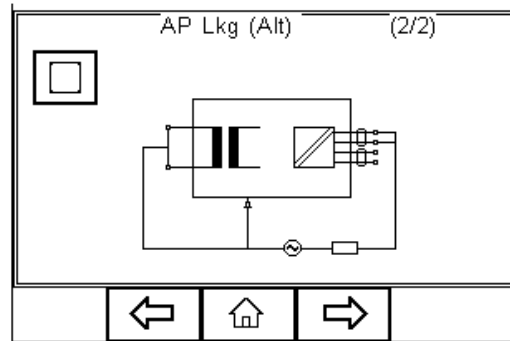
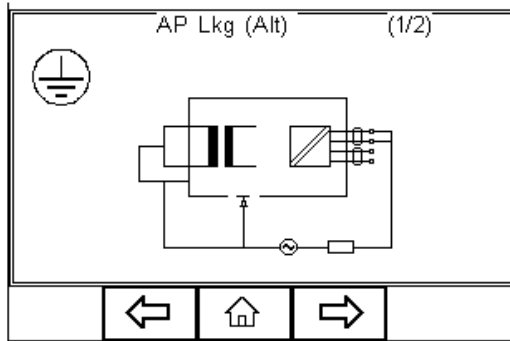
Press the  button (F1) to obtain the schematic representation of this test:



Press  button (F3) to set the Test Duration, Equipment Class, Applied Part module and RMS Pass/Fail limit for BF and CF Applied Parts. Use the up, down, left and right keys to highlight and set. Press  (F4) when complete. Pressing the  button (F3) will exit Settings mode without saving changes.

To configure the Applied Part Module press the  button (F1) in the Settings menu. For instructions on using this feature, see 3.2.2

For both Class 1 and Class II appliances, connect the Patient Connections or Applied Parts to the Applied Part Module as per the configuration above.

For Class I equipment use the earth bond lead (from the green socket) and connect to a conductive non-earthed part.

For Class II devices use the earth bond lead (from the green socket) and connect to the enclosure preferably encapsulated within conductive foil.

Press the green START key to begin the test. The test will run for the duration set or until the red STOP key is pressed.

5.1.10. Earth Leakage Test







Mains voltage applied to EUT

The Earth Leakage Test shows the current flowing through or via the insulation of the appliance into the protective earth conductor. The earth leakage test is important as it demonstrates the total leakage from the EUT.

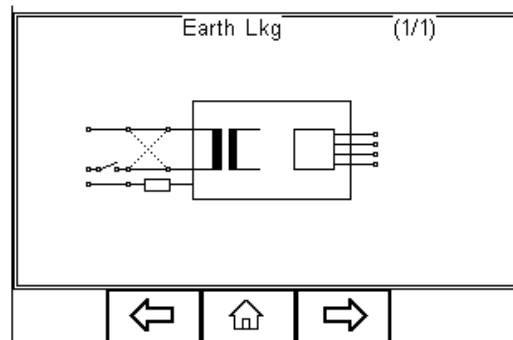
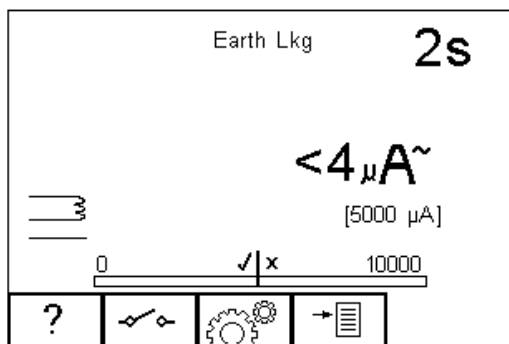

The earth leakage tests are valid for Class I equipment with Types B, BF and CF applied parts. This is an IEC 60601-1 test. For a complete description of this test and applicable pass / fail limits, please see Appendix A & B.

Press the  button (F1) to obtain the schematic representation of this test:



-  **Warning – never leave the earth bond, or any other probe attached to any moving parts.**
-  **Warning – never touch the appliance under test whilst testing is in progress. Doing so could result in injury due to electric shock and / or sudden movement of any mechanical parts on the appliance.**
-  **Refer to page 7 for notes on precautions required for compliance with the relevant safety standards.**
-  **Do not exceed the maximum permitted voltage of 30 V AC/DC with respect to earth potential! Electric Shock danger!**

Press the  button (F2) to toggle between the different single fault conditions and mains reversal.

Press  button (F3) to set the Test Duration and RMS Pass/Fail limit using the up, down, left and right keys to highlight and set. Press  (F4) when complete.

Pressing the  button (F3) will exit Settings mode without saving changes.

Plug the Medical Device in the Rigel 288 EUT socket and press the green START key to begin the test. The test will run for the duration set or until the red STOP key is pressed.

5.1.11. Enclosure Leakage Test







Warning Mains voltage applied to EUT

Enclosure Leakage displays the current that would flow if a person came into contact with the housing (or any accessible part not intended for treatment or care) of the appliance.

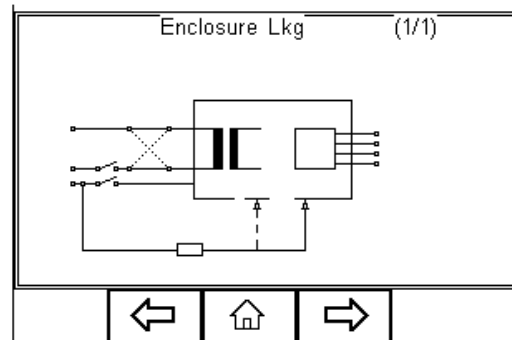
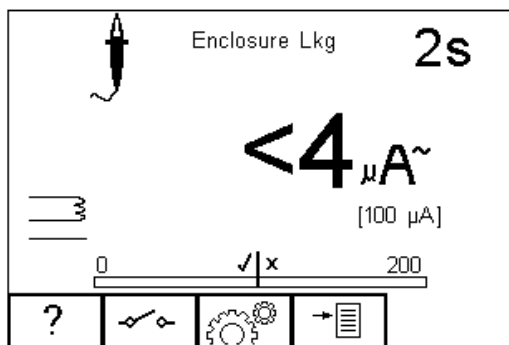

The Enclosure Leakage Test is valid for both Class 1 and Class II equipment with Types B, BF and CF Applied Parts. This is an IEC 60601-1 test. For a complete description of this test and applicable pass / fail limits, please see Appendix A & B.

Press the  button (F1) to obtain the schematic representation of this test:



-  **Warning – never leave the earth bond, or any other probe attached to any moving parts.**
-  **Warning – never touch the appliance under test whilst testing is in progress. Doing so could result in injury due to electric shock and / or sudden movement of any mechanical parts on the appliance.**
-  **Refer to page 7 for notes on precautions required for compliance with the relevant safety standards.**
-  **Do not exceed the maximum permitted voltage of 30 V AC/DC with respect to earth potential! Electric Shock danger!**

Press the  button (F2) to toggle between the different single fault conditions and mains reversal.

Press  button (F3) to set the Test Duration and RMS Pass/Fail limit using the up, down, left and right keys to highlight and set. Press  (F4) when complete. Pressing the  button (F3) will exit Settings mode without saving changes.



For Class I equipment, connect the earth bond lead (from the green socket) to a conductive part on the enclosure. Measure Enclosure Leakage on conductive non-earthed parts separately, by repositioning the probe.

For Class II devices connect the earth bond lead (from the green socket) to the conductive parts on the enclosure preferably encapsulated within conductive foil.

Press the green START key to begin the test. The test will run for the duration set or until the red STOP key is pressed.

5.1.12. Patient Leakage



Warning Mains voltage applied to EUT.

The Patient Leakage Current is the current flowing from the Applied Part via the patient to earth or flowing from the patient via an Applied Part to earth, which originates from an unintended voltage appearing on an external source.

The Patient Leakage Test is valid for both Class 1 and Class II equipment with Types B, BF and CF applied. This is an IEC 60601-1 test. For a complete description of this test and applicable pass / fail limits, please see Appendix A & B.

Press the  button (F1) to obtain the schematic representation of this test:

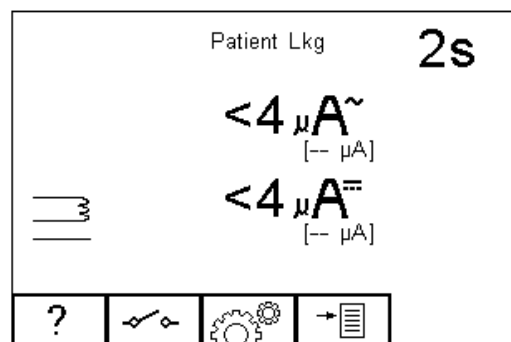
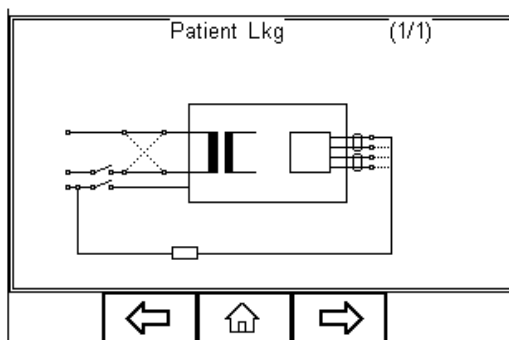



 **Warning – never leave the earth bond, or any other probe attached to any moving parts.**



 **Warning – never touch the appliance under test whilst testing is in progress. Doing so could result in injury due to electric shock and / or**

sudden movement of any mechanical parts on the appliance.

 Refer to page 7 for notes on precautions required for compliance with the relevant safety standards.

 Do not exceed the maximum permitted voltage of 30 V AC/DC with respect to earth potential! Electric Shock danger!

Press the  button (F2) to toggle between the different single fault conditions and mains reversal.

Press  button (F3) to set the Test Duration and RMS Pass/Fail limit using the up, down, left and right keys to highlight and set. Press  (F4) when complete.

Pressing the  button (F3) will exit Settings mode without saving changes.

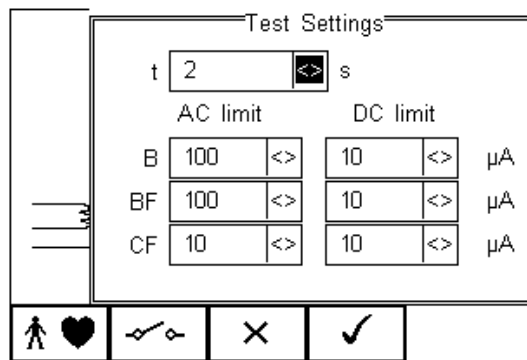

To configure the Applied Part Module press the  button (F1) in the Settings menu. For instructions on using this feature, see 3.2.2

For both Class 1 and Class II appliances, connect the Patient Connections or Applied Parts to the Applied Part Module as per the configuration above.

Press the green START key to begin the test. The test will run for the duration set or until the red STOP key is pressed.

5.1.13. Patient Leakage – F-Type



Warning Mains voltage applied to EUT.







Warning !!! This test involves applying a current limited mains potential (110% of mains input voltage) to the Applied Parts connections. Due to the requirements for IEC60601 this test current can be in excess of 5mA under short circuit conditions and as such is hazardous to the user. Caution should be taken when conducting this test. Current limiting is via a limiting resistor in series with the measurement circuit.

The Patient Leakage F-Type Test (also known as mains on Applied Parts test) displays the current that would flow if a mains potential was applied to the Applied Part which was attached to a patient (i.e. a single fault condition).

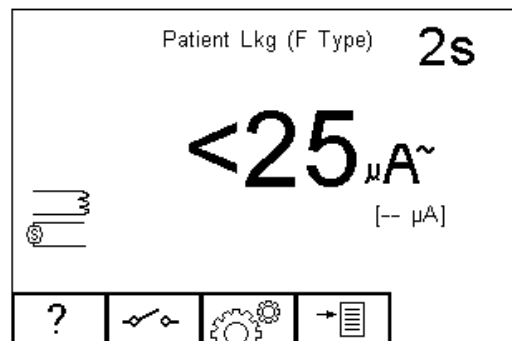
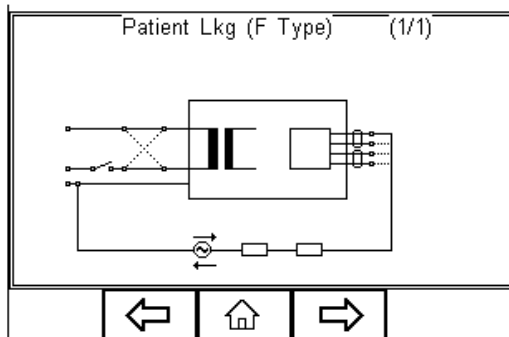

The F-type Leakage test is valid for both Class 1 and Class II equipment with BF and / or CF applied parts and are measured under mains normal or reverse and source voltage normal or reverse conditions. This is an IEC 60601-1 test. For a complete description of this test and applicable pass / fail limits, please see Appendix A & B.

Press the  button (F1) to obtain the schematic representation of this test:



-  **Warning – never leave the earth bond, or any other probe attached to any moving parts.**
-  **Warning – never touch the appliance under test whilst testing is in progress. Doing so could result in injury due to electric shock and / or sudden movement of any mechanical parts on the appliance.**
-  **Refer to page 7 for notes on precautions required for compliance with the relevant safety standards.**
-  **Do not exceed the maximum permitted voltage of 30 V AC/DC with respect to earth potential! Electric Shock danger!**

Press the  button (F2) to toggle between the different single fault conditions and mains reversal.

Press  button (F3) to set the Test Duration and RMS Pass/Fail limit using the up, down, left and right keys to highlight and set. Press  (F4) when complete.

Pressing the  button (F3) will exit Settings mode without saving changes.

To configure the Applied Part Module press the  button (F1) in the Settings menu. For instructions on using this feature, see 3.2.2

For both Class 1 and Class II appliances, connect the Patient Connections or Applied Parts to the Applied Part Module as per the configuration above.

Press the green START key to begin the test. The test will run for the duration set or until the red STOP key is pressed.

5.1.14. Patient Auxiliary Current





Warning Mains voltage applied to EUT.

The Patient Auxiliary Current displays the leakage current that would flow between Applied Parts under normal and fault conditions. For these tests, current is measured between a single part of the applied part and all other applied parts connected together.

The Patient Auxiliary Leakage test is valid for both Class 1 and Class II equipment with Types B, BF and CF applied parts. This is an IEC 60601-1 test. For a complete description of this test and applicable pass / fail limits, please see Appendix A & B.

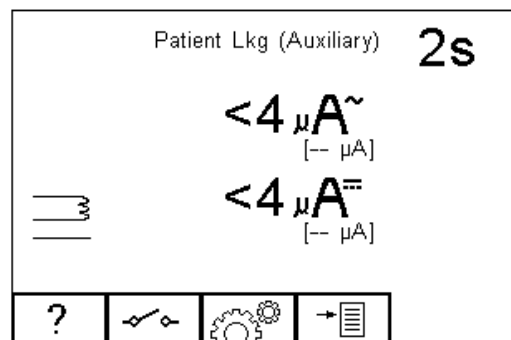
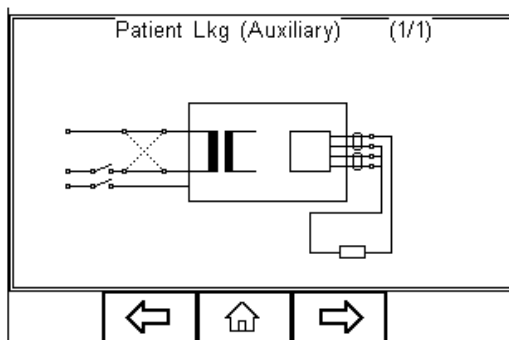
Press the  button (F1) to obtain the schematic representation of this test:





 **Warning – never leave the earth bond, or any other probe attached to any moving parts.**

 **Warning – never touch the appliance under test whilst testing is in progress. Doing so could result in injury due to electric shock and / or sudden movement of any mechanical parts on the appliance.**

 **Refer to page 7 for notes on precautions required for compliance with the relevant safety standards.**

 **Do not exceed the maximum permitted voltage of 30 V AC/DC with respect to earth potential! Electric Shock danger!**

Press the  button (F2) to toggle between the different single fault conditions and mains reversal.

Press  button (F3) to set the Test Duration and RMS Pass/Fail limit using the up, down, left and right keys to highlight and set. Press  (F4) when complete.

Pressing the  button (F3) will exit Settings mode without saving changes.

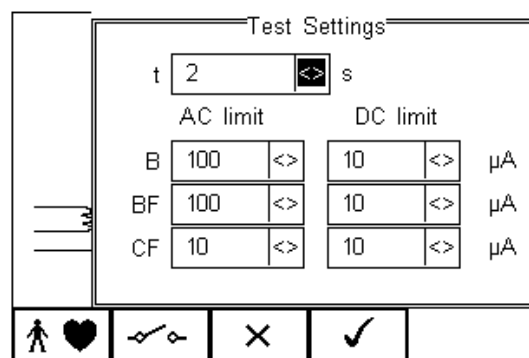

To configure the Applied Part Module press the  button (F1) in the Settings menu. For instructions on using this feature, see 3.2.2

For both Class 1 and Class II appliances, connect the Patient Connections or Applied Parts to the Applied Part Module as per the configuration above.

Press the green START key to begin the test. The test will run for the duration set or until the red STOP key is pressed.

5.1.15. Load Test





Warning Mains voltage applied to EUT.

This test provides a means of testing the Load current (in Amps) and power in KVA.

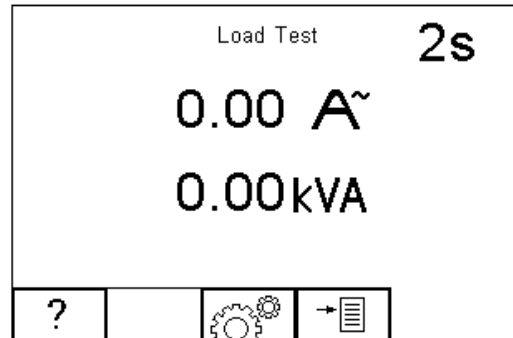
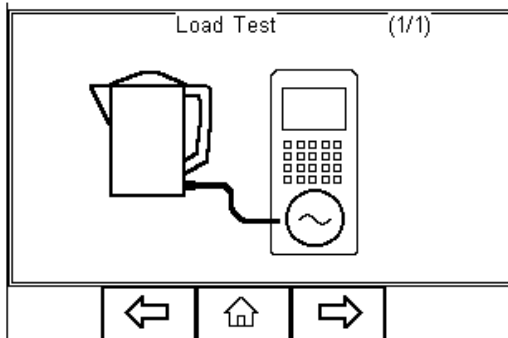
Press the  button (F1) to obtain the schematic representation of this test:



Press  button (F3) to set the Test Duration. Press  (F4) when complete.

Pressing the  button (F3) will exit Settings mode without saving changes.

Press the green START key to begin the test. The test will run for the duration set or until the red STOP key is pressed.



5.1.16. IEC Lead

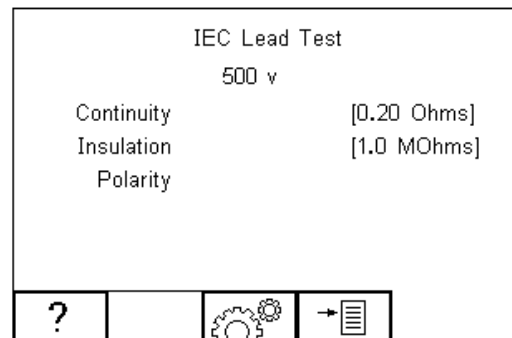
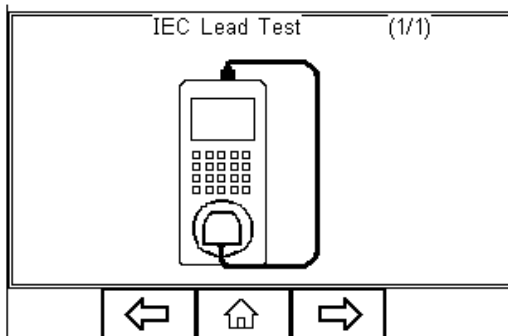

Warning Mains voltage applied to IEC Lead.

This test provides means of testing the continuity, insulation and polarity* of IEC test leads.



Press  button (F3) to set the Pass/Fail limits for Continuity, Insulation and Test Voltage. Use the up, down, left and right keys to highlight and set. The pass/fail limit for the continuity stage can be calculated using the Calc button (F2). Enter the type and length of cable and a new limit will be calculated. This can be overridden by selecting the limit from the list. Press  (F4) when complete. Pressing the  button (F3) will exit Settings mode without saving changes.

To perform an IEC lead test, connect the IEC socket side of the lead into the IEC inlet plug of the Rigel 288. Connect the mains plug side of the lead into the EUT socket, of the Rigel 288.

To start the IEC lead test, press the green START key.

The earth continuity resistance for the lead is measured using a $\pm 200\text{mA}$ test current. The display indicates the highest resistance and the pass/fail status. If this resistance is less than the pass/fail limit, then the insulation resistance will be measured.

 **During an insulation resistance measurement, a high voltage is applied between Live/Neutral and Earth of the IEC lead.**

The insulation resistance of the lead is measured over a period of 2 seconds. The display shows the final reading and the pass/fail status. If the insulation resistance is greater than the pass/fail limit, then the lead polarity will be checked.

The lead polarity stage checks for short and open circuit conditions on the live and neutral conductors. It also checks that the live and neutral wires are not crossed. When testing non-polarised IEC leads (e.g. Schuko mains leads) Live and Neutral can be crossed without implications. As such, this feature can be excluded. See section 3.4.6.

 **The polarity test is performed at mains voltage.**

The display shows the final result and the pass/fail status. See below.

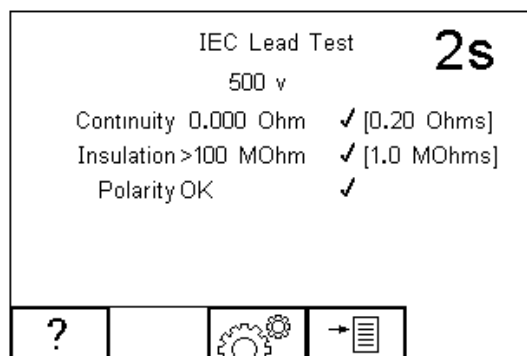

6. View Data

To view the stored data, press the  button (F4) and select View Data from the menu.

The following screen provides an overview of all available records in the memory, identified by Asset ID, Site and Pass or Fail.

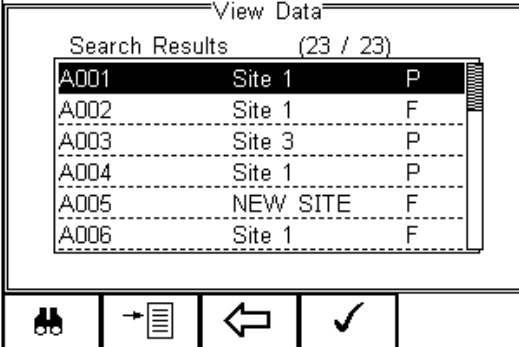

View Data

Search Results (23 / 23)

A001	Site 1	P
A002	Site 1	F
A003	Site 3	P
A004	Site 1	P
A005	NEW SITE	F
A006	Site 1	F

Navigation icons: Home, List, Back, Confirm

Use the up and down arrow keys to scroll through the database. When the desired record is highlighted, press the  button (F4) to enter the record and view the data.

This will display the Test Details Screen

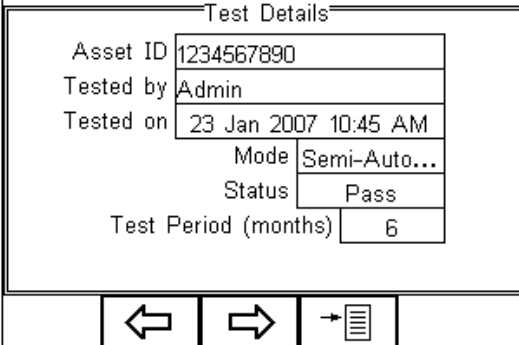

Test Details

Asset ID	1234567890
Tested by	Admin
Tested on	23 Jan 2007 10:45 AM
Mode	Semi-Auto...
Status	Pass
Test Period (months)	6

Navigation icons: Back, Forward, List

Use the  button (F2) to return to the main View Data screen.

Use the  button (F3) to view the Trace Variable and again to view the Applied Part setup. See below.

Asset Trace Variables	
Service Code	ABC
Site	Peterlee
Location	A&E
Make	DG Medical
Model	JB4000
Description	Patient Monitor
Serial Number	07W10L3M
Client	Durham NHS

AP Setup	
1	B 1 - 3
2	BF 4 - 6
3	CF 7 - 10

In the Test Details screen, press the  button (F4) to view the following options:

Test Details	
Asset ID	1234567890
Tested by	Admin
Tested on	23 Jan
Mo	
Stat	
Test Period (m)	

- View Results
- View Sequence
- User Comment
- Print Result
- Print Label
- Test'n'Tag

- **View Results** will display the results of the test (see section 6.1)
- **View Sequence** will display the test Sequence
- **User Comment** will allow the user to enter comments if required
- **Print Result** will print the result on the thermal printer (50 mm roll)
- **Print Label** will print a pass/fail label on the thermal printer (50 mm roll)
- **Test 'n Tag** will produce a thermal transfer pass/fail label. (see section 4.2 for more information)

6.1. View Results

Use the  button (F2) to return to the Test Details screen.

The  button (F4) provides the user with extra options to print results, print labels, Test 'n tag print or view results.

Use the up and down keys to select the view results option. Press the  button (F4) to display the view text results screen (see below).

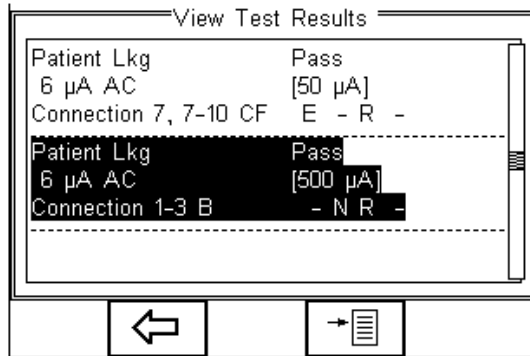

Use the  button (F2) to return to main menu.

6.2. Search the database

From the main View Data screen, press the  button (F1).

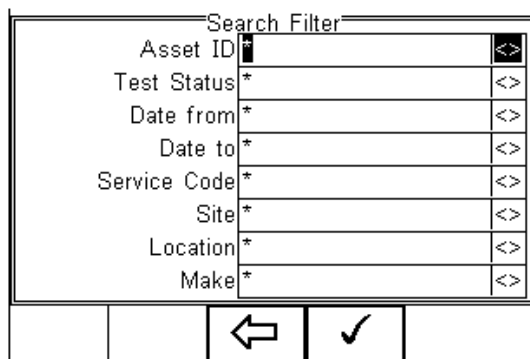

Use the up, down, left and right keys to navigate this screen.



The default setting is '*' which includes all records that Passed.
To search for more specific criteria, fill in the required fields by either using the keyboard or drop down boxes.



***The entered data must be identical to the data stored with the test.
This includes visible and invisible SPACE characters.***

***For Date entry use format DDMMYYYY or DD MM YYYY. For example
for 31st October 2007 us 31102007.***

Test Status Allows the user to select search criteria based on PASSED, FAILED or UPLOADED items.

To start the search, press the  button (F4) or the  button (F3) to leave this screen.

6.3. View Data Options

From the main View Data screen, press the  button (F2).

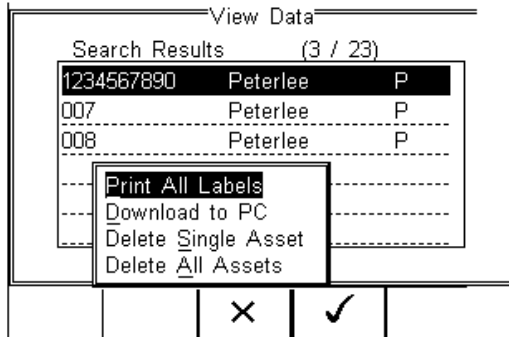

This will present an options menu to allow the user to:

Print All Labels – Will download all records within the search criteria to the Test 'n Tag printer, setup in Bluetooth favourites.

Download to PC – Will download all records within the search criteria to the PC, setup in Bluetooth favourites.

Delete Single Asset – Will delete the single selected record.



Delete All Assets – Will delete all records

from the memory (this action is irreversible).

7. Data Transfer

Data transfer is used to transfer records and configuration data to and from a PC load a logo in bitmap format for use with the Seaward Test 'n' Tag print system, and clone data.



The Data Transfer functions are accessed by pressing the  button (F4), selecting **Data Transfer** using the up and down keys and pressing the  button (F4).

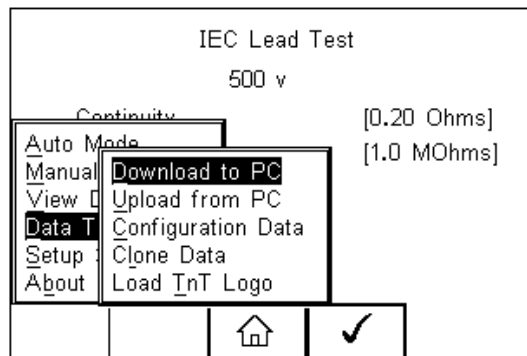

7.1. Download to PC

This feature is used to download records to a PC. Select Download to PC and press the  button (F4) to accept.



Later versions of firmware (V2.24 and higher will offer RS232 connectivity as alternative to Bluetooth.

The Rigel 288 will now attempt to make a Bluetooth connection with the Computer that has been configured in the Bluetooth Favourites.

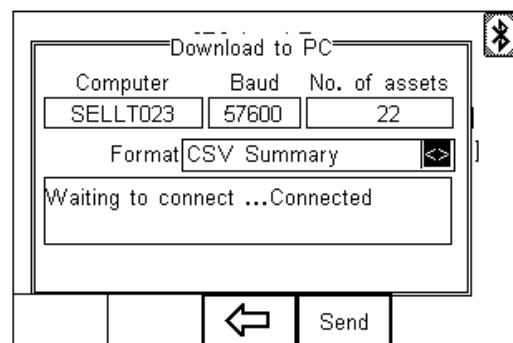
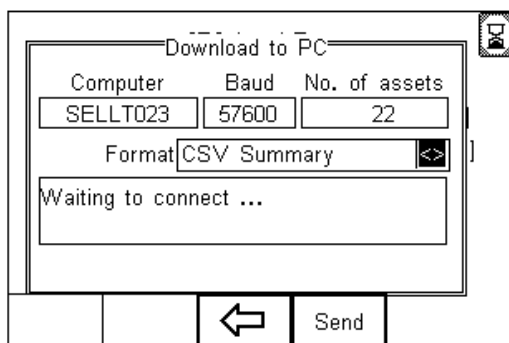

Initially, the Bluetooth status icon will display the egg timer for a few seconds, as shown

on the left, while the connection is established. When the connection is established and ready to communicate the Bluetooth status icon will change to show the Bluetooth icon as shown on the right.



The Rigel 288 is able to download in a number of formats to suit individual requirements. These are;

- CSV Full (Comma Separate Value, download only)
- CSV Summary (Comma Separate Value, download only)
- Rigel SSS (Up and download format)

Toggle between the options by using the left and right arrow keys.



Details on the RS232 format are available. Please contact our support department at +44(0) 191 5878701.

The Rigel 288 is now ready to transfer data. The No. of assets field shows the number of records that will be downloaded. Ensure that the PC application is ready to receive data then press the Send button (F4).

A progress bar, as shown below, will now follow the data transfer until download is complete.

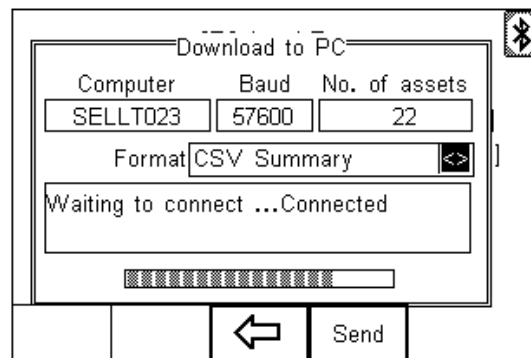

To download a selection of the database, refer to “View Data” (section 6). Search on the required criteria then select “download to pc” from the options menu.

7.2. Upload from PC

This feature is only available when used in combination with the new Med-eBase PC software and when the SSS format is activated on your device.

Select the Upload from PC option from the Data Transfer menu. The Rigel 288 will now attempt to establish a Bluetooth connection to the PC as previously described in Download to PC. The Rigel 288 is now ready to receive upload data from a PC. Refer to the Instruction manual of MediGuard plus on how to transmit data from the PC.





To activate the .SSS format on your Rigel 288 tester, please download the SSS Application note from our knowledge base.

Please visit; www.rigelmedical.com/knowledgebase/

7.3. Configuration Data

This feature can be used to transfer store or modify the current Trace Variables, User Profiles and Comment lists to/from a PC. It can be used to configure a number of Rigel 288 units with identical Trace Variable, User Profile and Comment lists.

7.3.1. Send Config Data

To send configuration data from a PC, press the  button (F4), and select Data Transfer using the up and down arrow keys, select Data and press the  button (F4). The Rigel 288 will now attempt to connect to the PC, setup in the Rigel 288 Bluetooth Favourites. When a connection has been established the display will be as shown below.

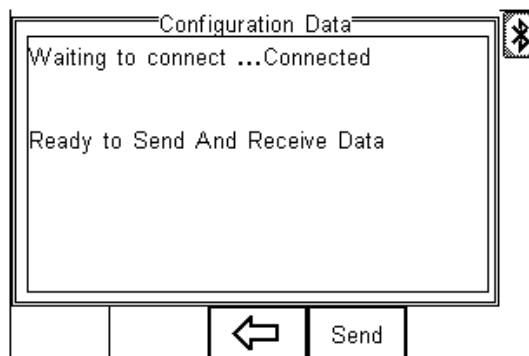

Open the Bluetooth Downloader (Data Transfer.exe) application on your PC and check that the Com Port is correct for the Bluetooth USB adaptor being used with the P.C. The baud rate will default to the correct value of 57600.

In the application, select Start Capture from the Capture menu in the task bar.
Enter a valid file name for the text file containing the download information; see below.

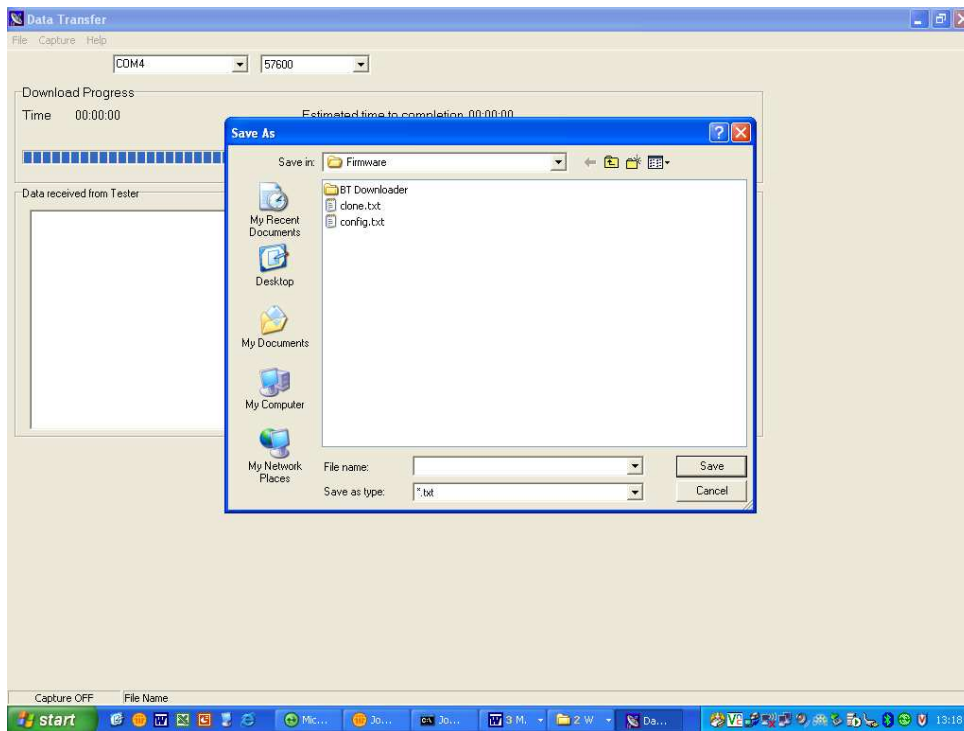

Once the text file has been created, press the Send button (F4) to transfer the Asset Trace variables and User names from the Rigel 288 to the PC.

The downloaded text will appear in the Bluetooth Downloader screen. Select Stop Capture from the Capture menu in the task bar. See below;

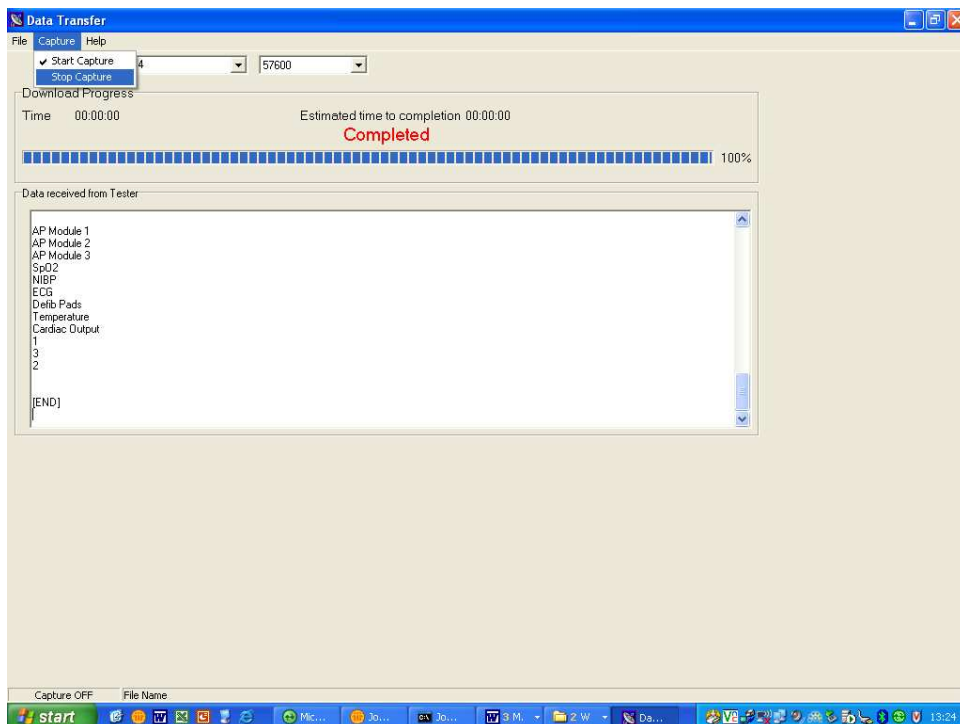

Close down the Application and open the text file using word pad or equivalent.

The downloaded information can be used to 'clone' other Rigel 288's or modified to add additional trace variables. Again these can be uploaded to any Rigel 288 for convenience.



The file transfer can be made using any suitable PC application such as the Seaward Bluetooth Downloader (Data Transfer.exe) or Hyperterminal capable of sending and receiving a text file.



The maximum number of entries for each field is SiteName (40), LocationName (50), UserName (40) and Comment (80).

7.3.2. Receive Config Data

Follow the steps above in Send Config Data to run the Bluetooth Downloader and connect the Rigel 288 to your PC.

Click on File on the Bluetooth Downloader menu and select Send File. This will open a window allowing you to select the text file containing your Trace Variables, User Profiles and Comments configuration data. Select the require file and click on Open. The Bluetooth Downloader will now transfer the configuration file to the Rigel 288.

When the transfer is complete the Rigel 288 screen will display a message as shown below.

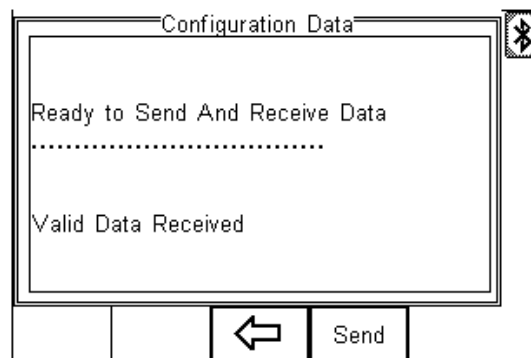

If the transfer is not successful, check that the format of the configuration file exactly matches that specified.



The Config file must be ASCII text and the last entry must be the [END] statement.

7.4. Clone Data

This feature can be used to transfer, store and copy the current Test Sequences and Test Codes to/from a PC. It can be used to configure a number of Rigel 288 units with identical Test Sequences and Test Codes.



The process is identical to transferring the Configuration Data as mentioned above. Due to the amount of data transferred, the Clone download will take longer than the Configuration Data transfer.

7.5. Load TnT Logo

A bitmap logo can be transferred to the Rigel 288 for use with the Seaward Test 'n' Tag print system.



The logo must be in .BMP format with a maximum size of 320 pixels by 240 pixels.

Press  button (F4), select Data Transfer using the up/down keys, select load T 'n' T logo and press the  button (F4).

The Rigel 288 will now attempt to connect to the PC, setup in Bluetooth Favourites. When a connection has been established the display will be as shown below.

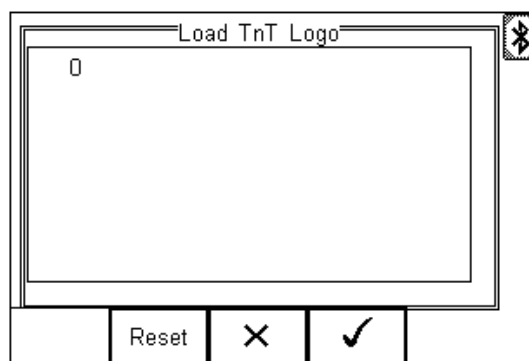

The Rigel 288 is now ready to receive data. The amount of data received is shown numerically on the top left of the display (0 in the screen shot above).

When using the Bluetooth Downloader application, select Send File from the File menu in the task bar. This will open a window allowing you to select the Bitmap file. Select the required Bitmap and click on Open. The Bluetooth Downloader will now transfer the file to the Rigel 288.

When the transfer is complete the Rigel 288 screen will display a message as shown below.

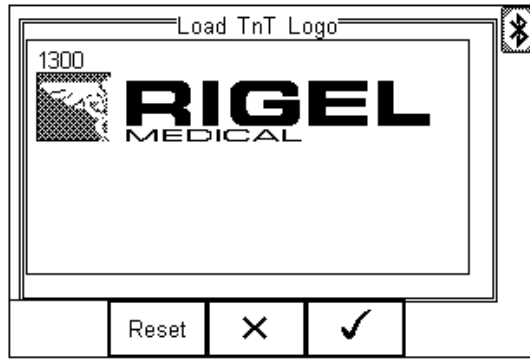

Press the  button (F4) to save the logo. The logo is now available for printing using the Seaward Test 'nTag printer.



The file transfer can be made using any suitable PC application such as the Seaward Bluetooth Downloader (data transfer.exe) or Hyperterminal.

8. About

This screen provides details on the Rigel 288's;

- Firmware version
- Serial Number
- Blue Tooth ID

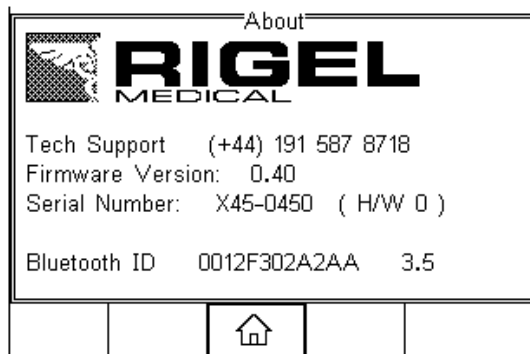

Ensure you have this information available when contacting Rigel Medical for Technical Support or Service. See chapter 9 for more information on Service and Calibration Procedures.

9. Maintaining the Rigel 288

9.1. *Cleaning the Analyser*

The Rigel 288 case can be cleaned with a damp cloth with, if necessary, a small amount of mild detergent. Prevent excessive moisture around the socket panel or in the lead storage area.

Do not allow liquid inside the Rigel 288 or near the sockets. Do not use abrasives, solvents or alcohol.

If any liquid is spilt into the Rigel 288 case, the Analyser should be returned for repair, stating the cause of the defect.

9.2. *User Maintenance*

The Rigel 288 is a rugged quality instrument. However, care should always be taken when using, transporting and storing this type of equipment. Failure to treat the product with care will reduce both the life of the instrument and its reliability.

If the Rigel 288 is subject to condensation, allow the Analyser to completely dry before use.

- ❖ Always check the Rigel 288 and all test leads for signs of damage and wear before use.
- ❖ Do not open the Rigel 288 under any circumstances.
- ❖ Keep the instrument clean and dry.
- ❖ Avoid testing in conditions of high electrostatic or electromagnetic fields.
- ❖ Maintenance should only be performed by authorised personnel.
- ❖ There are no user replaceable parts in the Rigel 288.
- ❖ The unit should be regularly calibrated (at least annually).

9.3. Return Instructions.

For repair or calibration return the instrument to:-

Rigel Medical
Service Dept.,
p.a. Seaward Electronic Limited.
Bracken Hill
South West Industrial Estate
Peterlee, Co. Durham
SR8 2SW, England

Tel : +44 (0)191 5878739
Fax: +44 (0)191 586 0227

sales@rigelmedical.com

calibration@seaward.co.uk

www.seaward.co.uk

www.rigelmedical.com

Prior to returning your unit for service, please contact our service department to obtain a Returns Number.

By obtaining a Returns Number, your service request can be booked in advance thus reducing the down time of your equipment.

When asking for a Returns Number, please quote:

- Instruments name and model
- Serial number (see section 8)
- Firmware version (see section 8)

10 Technical Specifications

Earth Continuity

Method	2 wire technique	using 'zero' lead function.
Test Current		>+200mA -200mA DC into 2 ohms
Max Test Voltage		4-24V rms o/c (6V for IEC 60601 tests)
Measuring Range (low range)		0.001 – 0.999 ohms @ 0.001 ohms resolution
Measuring Range (mid range)		1.00 – 9.99 ohms /@ 0.01 ohms resolution
Measuring Range (high range)		10.0 – 19.9 ohms @ 0.1 ohms resolution
Accuracy		± 3% of reading + 10 m ohms

Insulation Resistance

Measurement	EUT to Earth / Ground, EUT to AP and AP to Ground	
Voltage	250V DC & 500 V DC @1mA.	
Range (low range)	0.01Mohms - 20 Mohms	
Accuracy (low range)	± 5% of reading +2 counts	
Range (high range) @ 500VDC	20Mohms – 100Mohms	
Range (high range) @ 250VDC	20Mohms – 50Mohms	
Accuracy (high range)	±10% +2 counts	
Resolution	0.01Mohms	

Direct Leakage Measurement

Measuring Range	4µA to 9999µA	
Accuracy	± 5% or reading +2 counts	
Mains on A.P. voltage	F-type only @ 110% of mains	
Measuring Device	As per IEC 60601-1 requirements	
Measurement Type	Separate AC & DC for Patient (-Auxiliary) Leakage to IEC 60601, True RMS for all remaining Leakage tests	

Differential Leakage Measurement

Measuring Range	75µA to 9999µA	
Accuracy	±5% of reading + 5 counts	
Measurement / display resolution	1µA	
Measurement Type	True RMS	
Measuring Device	frequency response characteristics to IEC 60601-1.	

Alternative Leakage Measurements:

Test Voltage	250V at mains frequency
Test Current	3.5 mA current limited
Measurement Range	4 μ A to 9999 μ A
Measurement Resolution	1 μ A
Measurement Accuracy	\pm 5% of reading + 2 counts
Measurement Type	True RMS
Measuring Device	As per IEC 60601-1

Power Measurement

Method	VA rating.
Range	0.1KVA – 4KVA
Accuracy	\pm 10% + 2 counts

Mains Outlet Test

Input voltage range	0-300V AC
max current	16A
Measures	L – E, N – E and L -N
Accuracy	\pm 5% of reading + 2 counts

IEC Mains Lead Test

Test Duration	2s
Test	Continuity of all EB conductor, Insulation & Polarity

General

Mains power	230 VAC \pm 10%, 50Hz +/- 1Hz 120 VAC \pm 10%, 60Hz +/- 1Hz (USA model)
Battery	6 x 1.5V Alkaline AA
Weight	1.6 kg including batteries
Size (L x W x D)	270 x 110 x 75 mm / 10.5 x 4 x 3"
Operating conditions	0°C - 40°C, 0-90% RH - NC
Storage environment	-15°C - +60°C
Environmental Protection	IP 40

Appendix A Definition of IEC 60601 tests



Earth Continuity Tests

Earth bond Testing, also referred to as Ground bond Testing, tests the integrity of the low resistance connection between the earth conductor and any metal conductive parts, which may become live in case of a fault on Class I medical devices. Although many Class I medical devices are supplied with an earth reference point, most if not all medical devices require multiple earth bond tests to validate the connections of additional metal accessible parts on the enclosure.

The test current is applied between the earth pin of the mains supply plug and any accessible metal part (including earth reference point) via a dedicated earth bond test lead (clip/probe).

For fixed installations a Point-to-Point continuity measurement can be made by fitting a second lead into the Aux Earth socket. The resistance is then measured between the 2 leads.

Earth Leakage Test



Mains voltage applied to EUT

The Earth Leakage Test shows the current flowing through or via the insulation of the medical device into the protective earth conductor. The earth leakage test is important as it demonstrates the total leakage from the EUT.

The earth leakage tests are valid for Class I equipment with Types B, BF and CF applied parts.

IEC 60601-1 specifies that the measurements are done under normal and reverse operation and single fault condition (neutral open circuit). The earth leakage test is valid for Class I equipment with Types B, BF and CF applied parts. Appendix A shows the pass/fail limits as per IEC 60601-1 requirements.

Note - SFC 'Open Earth' cannot be performed as this would result in zero leakage measurements under all circumstances.

Diagram A shows a schematic interpretation of the earth leakage measurement including the relays operating the single fault conditions.

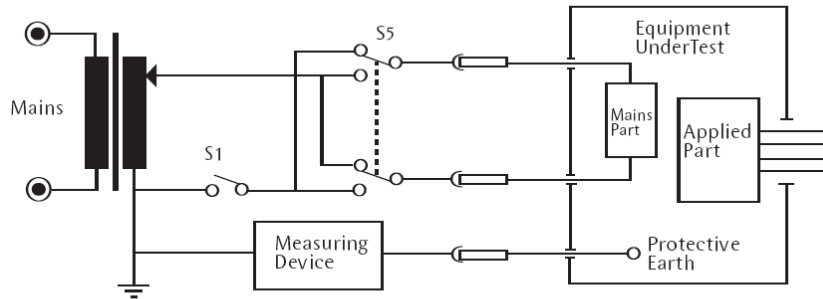

Diagram A - Test Circuit for Earth Leakage

Earth Leakage, normal conditions

This test measures the earth leakage current under normal conditions. The current is measured through the Measuring Device with S1 closed and S5 normal and then S5 reversed.

Earth Leakage, single fault, supply open

This test measures the earth leakage current with a single fault condition (supply open). The current is measured through the Measuring Device with S1 open and S5 normal and then S5 reversed.

Enclosure Leakage Test



Warning Mains voltage applied to EUT.

In general, Enclosure Leakage displays the current that would flow if a person would come in contact with the housing (or any accessible part not intended for treatment or care) of the medical device. IEC 60601-1 specifies that the measurements are done under normal and reverse operation of the mains supply and single fault conditions Open Neutral circuit and Open Earth.

The Enclosure Leakage Test is valid for both Class 1 and II equipment with Types B, BF and CF Applied Parts. Appendix A shows the pass/fail limits as per IEC 60601-1 requirements.

For enclosure leakage tests the earth bond probe is used to make contact with all conductive non-protectively earthed parts of the equipment.

When testing Class II devices, or fully insulated enclosures, the enclosure can be encapsulated by using aluminium foil of approximately 200 cm². The enclosure leakage is measured by connecting the aluminium foil to the leakage tester.

Note For Class II equipment, the Single Fault Earth Open tests are not required.

Diagram B shows a schematic interpretation of the earth leakage measurement including the relays operating the single fault conditions.

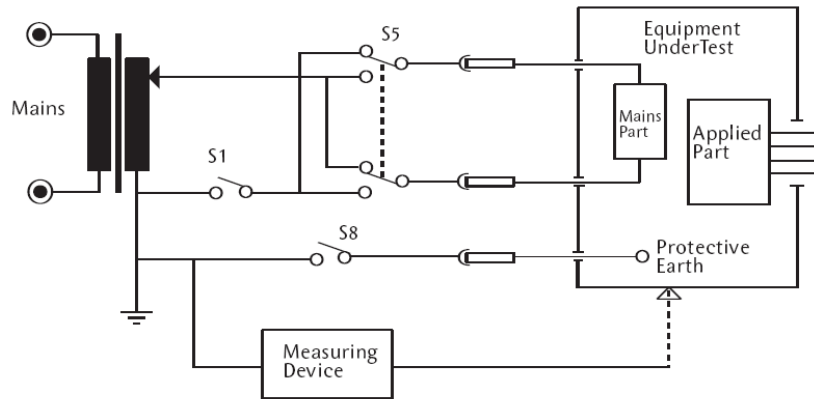

Diagram B - Test Circuit For Enclosure Leakage

Enclosure Leakage, normal condition

This test measures the enclosure leakage current under normal conditions. The current is measured through the Measuring Device with S1 and S8 closed and S5 normal and reversed.

Enclosure Leakage, single fault, supply open

This test measures the enclosure leakage current with a single fault condition (supply open). The current is measured through the Measuring Device with S1 open, S8 closed and S5 in normal and then S5 reversed

Enclosure Leakage, single fault, earth open

This test measures the enclosure leakage current with a single fault condition (earth open). The current is measured through the Measuring Device with S1 closed, S8 open and S5 in normal and then S5 reversed.

Patient Leakage



Warning Mains voltage applied to EUT.

The Patient Leakage Current is the current flowing from the Applied Part via the patient to earth or flowing from the patient via an Applied Part to earth, which originates from an unintended voltage appearing on an external source.

The Patient Leakage Test is valid for both Class 1 and II equipment with Types B, BF and CF applied.

IEC 60601-1 specifies that the measurements be done under normal and reverse operation of the mains supply and single fault conditions Open Neutral circuit and Open Earth. Appendix A shows the pass/fail limits as per IEC 60601-1 requirements.

Note For Class II equipment, the Single Fault Earth Open tests are not required.

For type CF equipment the patient leakage current is measured from each applied part separately however, for type B and BF equipment, the patient leakage current is measured with all applied parts connected together.

Diagram C shows a schematic interpretation of the Patient Leakage measurement including the relays operating the single fault conditions.

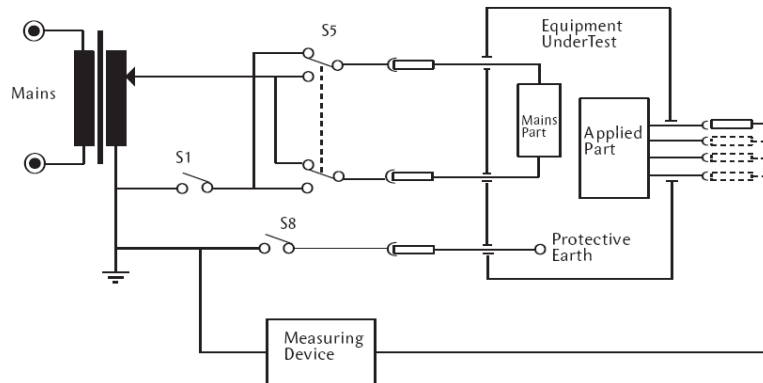

Diagram C - Test Circuit For Patient Leakage Current

Patient Leakage, normal condition

This test measures the patient leakage current under normal conditions. The current is measured through the Measuring Device with S1 and S8 closed, S5 normal and then S5 reversed.

Patient Leakage, single fault, supply open

This test measures the patient leakage current with a single fault condition (supply open). The current is measured through the Measuring Device with S1 open, S8 closed and S5 normal and then S5 reversed.

Patient Leakage, single fault, earth open

This test measures the patient leakage current with a single fault condition (earth open). The current is measured through the Measuring Device with S1 closed, S8 open and S5 normal and then S5 reversed.

Note – this test is not performed on class II equipment.

Patient Leakage – F-Type



Warning Mains voltage applied to EUT.



Warning !!! This test involves applying a current limited mains Potential(110% of mains input voltage) to the Applied Part connections. Due to the requirements for IEC60601 this test current can be in excess of 5mA under short circuit conditions and as such is hazardous to the user. **Caution**

should be taken when conducting this test. Current limiting is via a limiting resistor in series with the measurement circuit.

The Patient Leakage F-Type Test (also known as mains on Applied Parts test) displays the current that would flow if a mains potential was applied to the Applied Part which was attached to a patient (i.e. a single fault condition).

The F-type Leakage test is valid for both Class 1 and II equipment with BF and / or CF Applied Part only and are measured under mains normal or reverse and source voltage normal or reverse conditions. Appendix A shows the pass/fail limits as per IEC 60601-1 requirements.

This test involves applying a current limited mains potential (110% of mains input voltage) to the Applied Parts connections. Due to the requirements for IEC 60601-1 this test current can be in excess of 5mA under short circuit conditions and as such is hazardous to the user.

Caution should be taken when conducting this test. Current limiting is via a limiting resistor in series with the measurement circuit.

IEC60601-1 specifies that leakage current for type CF Applied Parts is measured from each of the patient connection / applied parts separately. For type BF equipment the leakage current is measured with all parts of the same type applied parts connected together, shown dotted below.

Diagram D shows a schematic interpretation of the F-Type Leakage measurement including the relays operating the single fault conditions.

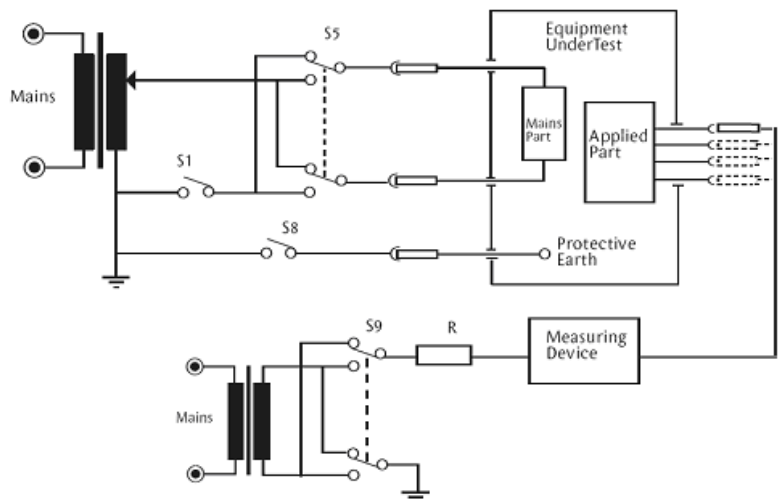

Diagram D - Test Circuit For Patient Leakage Current, Mains On Applied Part

IEC60601-for type BF equipment the leakage current is measured with all parts of the applied part connected together, shown dotted above. For type CF equipment the leakage current is measured from each of the applied parts separately

Note – for this test ‘body model’ selection will be IEC60601.

The current is measured through the Measuring Device with S1 and S8 closed. S5 and S9 are switched between normal and reversed.

Patient Auxiliary Current



Warning Mains voltage applied to EUT.

The Patient Auxiliary Current displays the leakage current that would flow between Applied Parts under normal and fault conditions. For these tests, current is measured between a single part of the applied part and all other applied parts connected together. This test should be repeated until all combinations have been tested. This is also referred to as Applied Part to All.

The Patient Auxiliary Leakage test is valid for both Class I and II equipment with Types B, BF and CF applied.

IEC 60601-1 specifies that the measurements be carried out under normal and reverse operation of the mains supply and single fault conditions Open Neutral circuit and Open Earth.

Note For Class II equipment, the Single Fault Earth Open tests are not required.

Diagram E shows a schematic interpretation of the Patient Auxiliary Leakage measurement including the relays operating the single fault conditions.

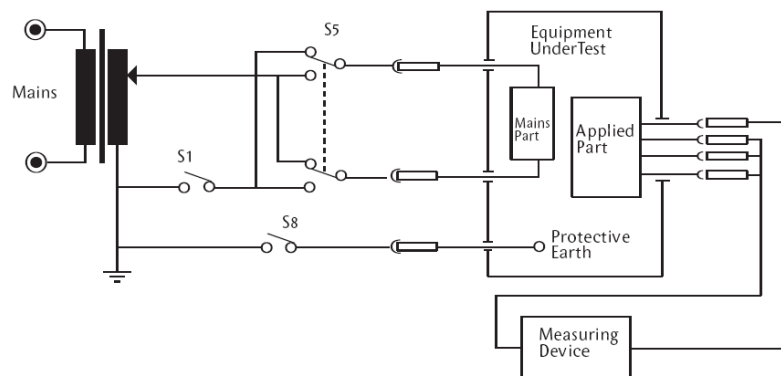

Diagram E - Test Circuit For Patient Auxiliary Current

For these tests, current is measured between a single part of the applied part and all other applied parts connected together. This test should be repeated until all combinations have been tested.

Patient Auxiliary, normal condition

This test measures the patient auxiliary current under normal conditions. The current is measured through the Measuring Device with S1 and S8 closed, S5 normal and then S5 reversed.

Patient Auxiliary, single fault, supply open

This test measures the patient auxiliary current under a single fault condition (supply open). The current is measured through the Measuring Device with S1 open, S8 closed and S5 normal and then S5 reversed.

Patient Auxiliary, single fault, earth open

This test measures the patient auxiliary current under a single fault condition (earth open). The current is measured through the Measuring Device with S1 closed, S8 open and S5 normal and then S5 reversed.

Appendix B Pass / Fail Limits of IEC 60601-1

Earthbond test limit at 25A, 50Hz

Excluding power cord				< 0.1 Ω		
Including power cord				< 0.2 Ω		
	Type B Applied Parts		Type BF Applied Parts		Type CF Applied Parts	
Leakage Current Type	NC	SFC	NC	SFC	NC	SFC
Earth Leakage (General)	500 μ A	1000 μ A	500 μ A	1000 μ A	500 μ A	1000 μ A
Enclosure Leakage	100 μ A	500 μ A	100 μ A	500 μ A	100 μ A	500 μ A
Patient Leakage (dc)	10 μ A	50 μ A	10 μ A	50 μ A	10 μ A	50 μ A
Patient Leakage (ac)	100 μ A	500 μ A	100 μ A	500 μ A	10 μ A	50 μ A
Patient Leakage (F-Type)	NA	NA	NA	5000 μ A	NA	50 μ A
Patient Leakage (Mains on SIP/SOP)	NA	5mA	NA	NA	NA	NA
Patient Auxiliary Current (dc)	10 μ A	50 μ A	10 μ A	50 μ A	10 μ A	50 μ A
Patient Auxiliary Current (ac)	100 μ A	500 μ A	100 μ A	500 μ A	10 μ A	50 μ A

Appendix C Definition of IEC 62353 tests

Earth Continuity Tests

Earth bond Testing, also referred to as Ground bond Testing, tests the integrity of the low resistance connection between the earth conductor and any metal conductive parts, which may become live in case of a fault on Class I medical devices. Although many Class I medical devices are supplied with an earth reference point, most if not all medical devices require multiple earth bond tests to validate the connections of additional metal accessible parts on the enclosure.

The test current is applied between the earth pin of the mains supply plug and any accessible metal part (including earth reference point) via a dedicated earth bond test lead (clip/probe).

For fixed installations a Point-to-Point continuity measurement can be made by fitting a second lead into the Aux Earth socket. The resistance is then measured between the 2 leads.

Equipment Leakage

The Equipment Leakage Test measures the total leakage deriving from the Applied Parts, Enclosure and Mains Parts combined to real earth.

The Equipment Leakage Test is applicable to both Class I and II, B, BF and CF equipment.

All Patient Connections and Applied Parts (B / BF & CF) are connected together.

The test is conducted with the **protective earth connection interrupted** to ensure the measurements are done under worst conditions. As such, any earth leakage current will be measured as part of the enclosure (or touch) leakage.

Leakage measurements to IEC 62353 are done using the RMS value instead of the separate AC and DC values used in the IEC 60601-1 standard.

The IEC 62353 specifies three different methods of measuring the Equipment Leakage Current;

- **Direct Method**
- **Differential Method**
- **Alternative Method**



Direct method: The 1k Ω measuring device (equivalent to that used in the IEC 60601 standard – see Appendix E) is positioned in the leakage return path to earth. Measurements are done in both polarities of the incoming mains with the protective earth to the EUT interrupted.

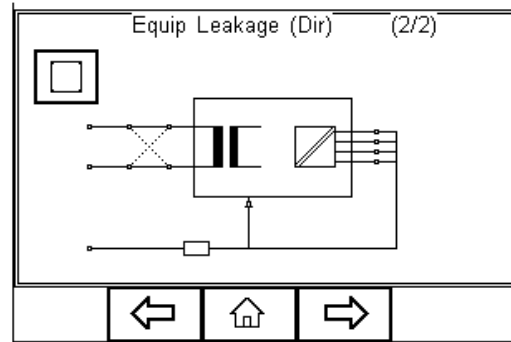
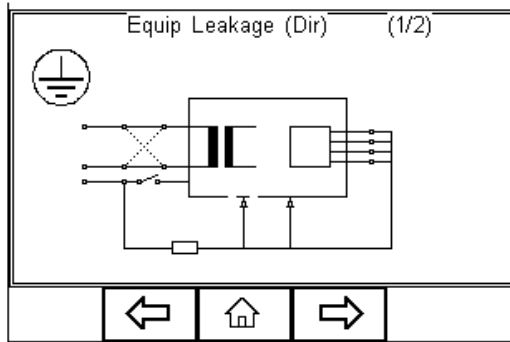

All Applied Parts and earthed (eg enclosure Class I) and non-earthed accessible conductive parts or non-conductive accessible parts (enclosure Class II) are grouped together and connected to earth via the 1k Ω Measuring Device (Body Model).

The EUT must be positioned floating to avoid secondary earth connections influencing the measuring process.

Differential method; The 1k Ω measuring device (equivalent to that used in the IEC 60601 standard – see Appendix E) is positioned as part of a differential current measurement between the Live and neutral conductor.

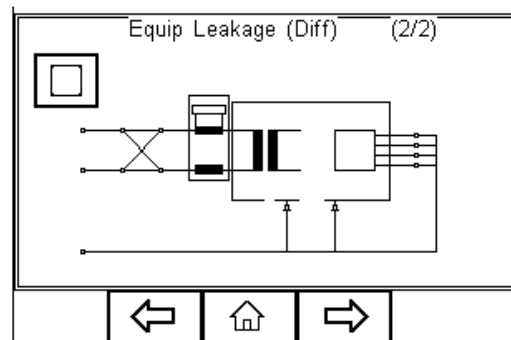
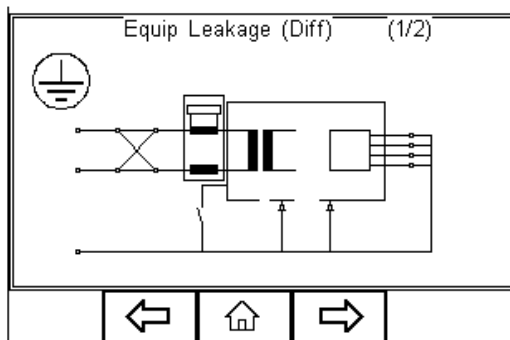

Measurements are done in both polarities of the incoming mains with the protective earth to the EUT interrupted.

All Applied Parts and earthed (eg enclosure Class I) and non-earthed accessible conductive parts or non-conductive accessible parts (enclosure Class II) are grouped together and connected to earth to allow the Differential circuit to measure the total leakage current.

Due to the Differential measuring method, potential secondary earth connections are included in the total measurement and as such, the EUT doesn't require to be positioned isolated from earth.

Low leakage currents of less than 75 μ A are difficult to measure using the Differential Leakage method. As such the Differential Leakage method is unsuitable for measuring

conductive un-earthed parts and in those instances where leakages are expected to be below 75 μ A.

Alternative method; This method is in fact similar to a dielectric test between the mains parts and all accessible parts (conductive and non-conductive) including the Applied Parts connected together.

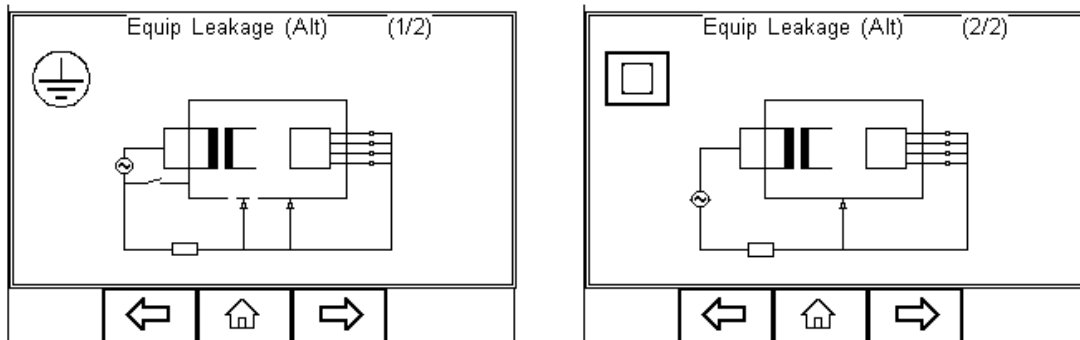

The test is performed using current limited (3.5mA) mains potential sinusoidal 50Hz signal. (60Hz where this is the mains frequency)

The 1k Ω measuring device (equivalent to that used in the IEC 60601 standard – see Appendix E) is positioned directly after the voltage source.

Measurements are with the protective earth to the EUT interrupted.

As Live and neutral are shortened, the Device will not be powered and mains reversal is not applicable.

Due to the Alternative measuring method, the EUT doesn't require to be positioned isolated from earth.

The Alternative Method is not suitable for equipment having active circuitry and relies on incoming mains to be fully exposed to the potential leakage.

The Alternative method is highly repeatable and as such is ideal for trend analysis on Medical Equipment not including active circuitry.

Applied Part Leakage

The Applied Part Leakage Test measures the total leakage deriving from the combined Patient Connections within an Applied Part to earth and any conductive or non conductive parts on the enclosure (either connected or isolated from earth) under the fault condition Mains on Applied Parts.

The Applied Part Leakage Test is applicable to Floating type (BF & CF) Applied Parts only either Class I or II.

All Patient Connections of a single function within an Applied Part shall be connected together (BF & CF) and measured one at the time.

Applied Parts (& Patient Connections) not part of the measurement shall be left floating. (ie not connected to real earth).

The test is conducted by applying a current limited (3.5mA) mains potential sinusoidal 50Hz signal (60Hz where this is the mains frequency) between the Applied Part and the Enclosure and Earth connection of the EUT connected to real Earth.

Leakage measurements to IEC 62353 are done using the RMS value instead of the separate AC and DC values used in the IEC 60601-1 standard.

The IEC 62353 / Applied Part Leakage can be performed in two different methods;

- **Direct Method**
- **Alternative Method**

Direct method: The 1k Ω measuring device (equivalent to that used in the IEC 60601 standard – see Appendix E) is positioned in the leakage return path to earth between the Applied Part and the real earth grouped with EUT earth and conductive parts not connected to earth (Class I) or the real earth connected to the Class II enclosure.

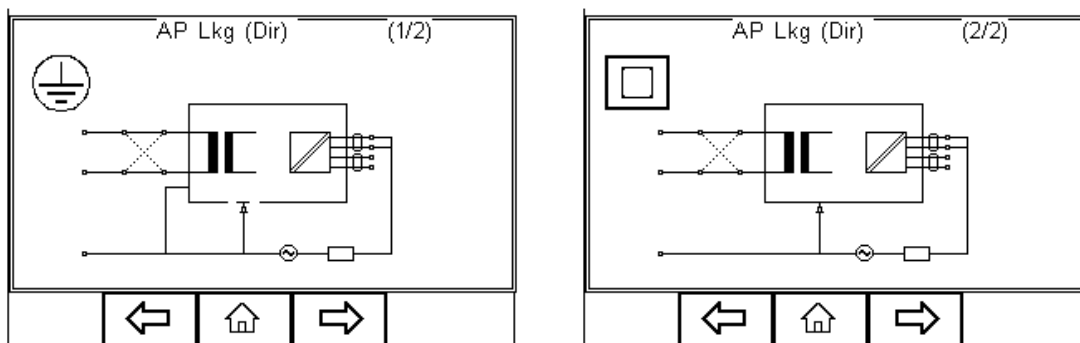

Measurements are done in both polarities of the incoming mains.

The EUT must be positioned floating to avoid secondary earth connections influencing the measuring process.

Warning This Applied Part Direct Leakage test is similar to that of the F-Type leakage test according to IEC 60601 using a equivalent current limited voltage source to produce the mains potential. Both sources depend on a current limiting resistor which could cause a significant voltage drop.

Unlike the IEC 60601-1 requirements, the voltage drop caused by the current limiting resistor **is compensated for** in the IEC 62353 thus potentially resulting in a higher reading than the typical IEC 60601-1 F-type test. Please refer to the manufacturers recommendations.

Alternative method; This method is in fact similar to a dielectric test between the Applied Part and all mains parts, EUT earth and Enclosure connected together.

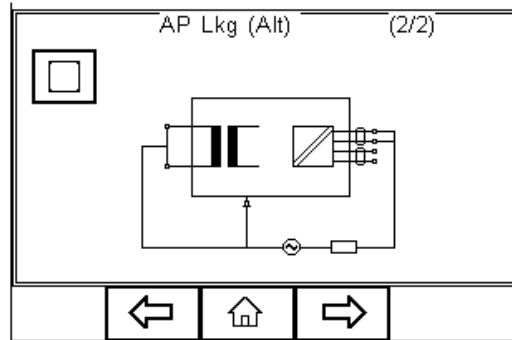
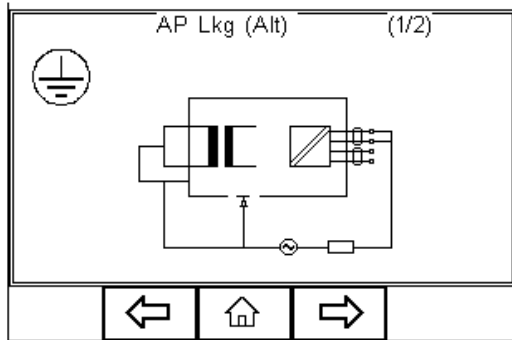

The test is performed using a current limited (3.5mA) mains potential sinusoidal 50Hz signal. (60Hz where this is the mains frequency)

The 1kΩ measuring device (equivalent to that used in the IEC 60601 standard – see Appendix E) is positioned between the Applied Part and voltage source.

As Live and neutral are shortened, the Device will not be powered and mains reversal is not applicable.

Due to the Alternative measuring method, the EUT doesn't require to be positioned isolated from earth.

The Alternative Method is not suitable for equipment having active circuitry and relies on incoming mains to fully expose the potential leakage.

The Alternative method is highly repeatable and as such is ideal for trend analysis on Medical Equipment not including active circuitry.

Appendix D Pass / Fail limits of IEC 62353

Current in μA (RMS)	APPLIED PART		
	Type B	Type BF	Type CF
Equipment Leakage – alternative method			
– Class I Equipment	1000 μA	1000 μA	1000 μA
– Class II Equipment	500 μA	500 μA	500 μA
Equipment leakage – direct or differential method			
– Class I Equipment	500 μA	500 μA	500 μA
– Class II Equipment (touch current)	100 μA	100 μA	100 μA
Patient leakage current – alternative method (a.c.)			
– Class I & II		5000 μA	50 μA
Patient leakage current – direct method (a.c.)			
– Class I & II		5000 μA	50 μA
<p>NOTE 1 This IEC 62353 standard does not provide measuring methods and allowable values for equipment producing d.c. leakage currents. In such a case the manufacturer should give information in accompanying documents.</p> <p>NOTE 2 Particular standards may allow different values of leakage current</p>			

Appendix E IEC 60601-1 Measuring Device

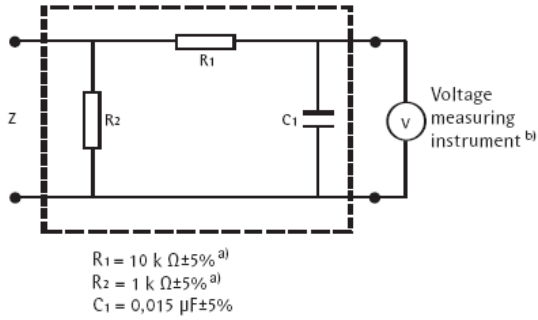

a) Measuring device

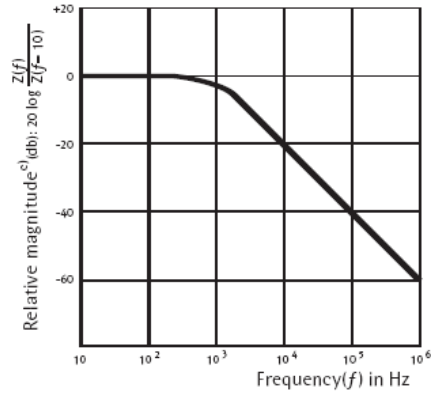

b) Frequency characteristics

NOTE The network and voltage measuring instrument above are replaced by the symbol  in the following figures

^{a)} Non inductive components

^{b)} Impedance \gg measuring impedance Z

^{c)} $Z(f)$ is the transfer impedance of the network, i.e. V_{out}/i_{in} , for a current frequency f .

Example of a measuring device MD according to IEC 60601-1 and its frequency characteristics

Appendix F Firmware Route Map

Auto Mode

Manual Mode	<i>Earth Bond</i>		
	<i>Insulation ></i>	Insulation EUT	
		Insulation AP	
		Insulation AP to mains	
	<i>IEC 62353 ></i>	Equipment Leakage Test >	Direct
			Alternative
			Differential
		AP Leakage Test >	Direct
			Alternative
	<i>IEC 60601-1 ></i>	Earth leakage	
		Enclosure Leakage	
		Patient Leakage	
		Patient Lkg (Auxiliary)	
		Patient Lkg (F-Type)	
	<i>Load test</i>		
	<i>IEC lead test</i>		

View Data

Data Transfer	<i>Download to PC</i>
	<i>Upload fro PC</i>
	<i>Configuration Data</i>
	<i>Clone Data</i>
	<i>Load T'nT Logo</i>

Setup	<i>Test Sequences</i>	
	<i>Test Codes</i>	
	<i>Asset Trace Variables</i>	
	<i>System Config</i>	
	<i>Bluetooth Favourites</i>	
	<i>User Admin ></i>	Preferences
		Chance User
		Change Password
		User Profile
	<i>Memory Options</i>	
	<i>Restore Factory Settings</i>	

About

Appendix G Available Application Notes

The following application notes are available online via our knowledgebase on;

<http://www.rigelmedical.com/knowledgebase/>

0001-Definitions IEC 60601-62353

0002-Testing on isolated supply

0003-Testing equipment sensitive to power breaks

0004-IEC60601 Symbols and Markings

0005-Uploading Tnt logo into Rigel 288

0008-Tests available on the Rigel 288

0009-Testing fixed wired or 3-phase equipment

0011-01 Different Leakage Methods

0011-Different Leakage Methods

0012-Setting up the right printer in the Rigel 288

0013-Activating optional features 288

0014-Download using BT Offloader

0015-Quick Start to BT scanner

0016-Maximum data on Rigel 288

0017-Testing to IEC 61010 on Rigel 288

0018-339A650 Belkin Bluetooth Adapter - Vista Application Note

0019-Med-eBase SQL error

Appendix H Connection diagram AP box

